

HIOKI

DT4261

Instruction Manual

DIGITAL MULTIMETER



Read carefully before use.
Keep for future reference.

EN

Dec. 2021 Revised edition 1
DT4261A961-01 21-12H



* 6 0 0 6 2 0 9 6 1 *

Contents

Introduction.....	1
Checking Package Contents	2
Options	2
Notations	6
Safety Information	9
Precautions for Use.....	13

1 Overview 19

1.1 Overview and Features	19
1.2 Part Names and Functions	20
1.3 Alarm Display and Battery Indicator	28

2 Preparing for Measurements 29

2.1 Measurement Procedure	29
2.2 Inserting/Replacing Batteries	30
Battery installation/replacement procedure	33
2.3 Use of Test Leads.....	35
L9300 Test Lead (accessory).....	36
L9207-10 Test Lead (option).....	39
2.4 Installing Wireless Adapter	41
Z3210 Wireless Adapter installation procedure	42
2.5 Instrument Installation in the Measurement Location	44
Using the instrument with the stand.....	44
Using magnetic strap	45
Magnetic strap attachment procedure	47
Strap attachment procedure	49

3 Measurement 51

3.1 Inspecting the Instrument Before Use	51
--	----

3.2	Voltage Measurement	58
	Measuring DC voltage, AC voltage, and DC/AC composite voltage.....	59
	Measuring AC voltage.....	60
	Measuring voltage with low input impedance	61
3.3	Frequency Measurement.....	62
3.4	Continuity Check.....	63
3.5	Diode Voltage Measurement	64
3.6	Resistance Measurement	65
3.7	Electrostatic Capacity Measurement	66
3.8	Current Measurement	68
	Measuring AC current	69
	Measuring DC current/AC current	70
3.9	Measurement with Clamp On Probe (AC Current).....	71
3.10	DC High V Probe Mode	73
	Preparation	74
	Making Measurements	75

4 Convenient Usage 77

4.1	Measurement Range Selection	77
	Measuring with the auto range	77
	Measuring with the manual range.....	78
4.2	Hold Function (HOLD)	79
	Retaining the measured value manually (HOLD)	79
	Retaining the measured value automatically (AUTO HOLD).....	80
4.3	Filter Function (FILTER).....	83
4.4	Maximum, Minimum, Average, and Peak Values	86
	Displaying MAX, MIN, AVG, PEAK MAX, and PEAK MIN in order	86

	Displaying “MAX and MIN” or “PEAK MAX and PEAK MIN” simultaneously.....	87
4.5	Zero Adjustment.....	88
4.6	Backlight.....	90
	Display backlight.....	90
	Warning backlight (Red)	90
4.7	Auto Power Save (APS).....	91
4.8	DC Voltage Positive/Negative Judgment Function.....	92
4.9	Communication with the PC.....	93
4.10	Wireless Communications Function.....	96
	Using GENNECT Cross.....	96
	Z3210-to Excel® direct data entry function (Excel® direct input function, HID function).....	99
4.11	Power-On Option Table.....	103

5 Specifications 109

5.1	General Specifications.....	109
5.2	Input and Measurement Specifications	112
	Basic specifications	112
5.3	Other Specifications.....	131
	Interface specifications	131

6 Maintenance and Service 133

6.1	Repairs, Calibration, and Cleaning.....	133
	Calibration.....	133
	When exposed to water during storage	134
	When condensation occurs	135
	Cleaning.....	136
	Shipping Precautions.....	136
	Disposal	136

6.2	Troubleshooting	137
	Before returning for repair.....	137
6.3	Error and Operation Display	141
6.4	Fuse Replacement	142
	Fuse replacement procedure.....	144
7	Appendix	147
	7.1 RMS and Average.....	147
Index		149
Warranty Certificate		

Introduction

Thank you for choosing the Hioki DT4261 Digital Multimeter. To ensure your ability to get the most out of this instrument over the long term, please read this manual carefully and keep it available for future reference.

Carefully read the separate document entitled “Operating Precautions” before use.

Latest edition of instruction manual

The contents of this manual are subject to change, for example as a result of product improvements or changes to specifications.

The latest edition as well as multilingual editions of the manual (in Chinese, French, German, Italian Korean, and Spanish) can be downloaded from Hioki’s website.

<https://www.hioki.com/global/support/download>



Intended audience

This manual has been written for use by individuals who use the product or provide information about how to use the product. In explaining how to use the product, it assumes electrical knowledge (equivalent of the knowledge possessed by a graduate of an electrical program at a technical high school).





Trademarks

- Microsoft Excel is either registered trademarks or trademarks of Microsoft Corporation in the United States and other countries.
- The Bluetooth® word mark and logos are registered trademarks owned by Bluetooth SIG, Inc. and any use of such marks by Hioki E.E. Corporation is under license. Other trademarks and trade names are those of their respective owners.

Checking Package Contents

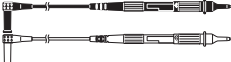
When you open the package, carefully inspect the instrument to ensure that everything is in good condition, and that no damage occurred during shipping. Carefully check the accessories, panel keys, and connectors. If the instrument seems to have been damaged or does not work as specified, contact your authorized Hioki distributor or reseller.

Check the package contents as follows.

Instrument	Accessories
 <p>A blue and grey Hioki digital multimeter with a large LCD screen at the top. Below the screen are buttons for 'MULTI/FUNK', 'FILTER', 'RANGE', and 'HOLD'. A large rotary dial is in the center, and there are several input jacks at the bottom labeled 'A', 'COM', 'V', and 'Ω'. The text 'DT408B-1 DIGITAL MULTIMETER' is printed at the bottom of the device.</p>	<input type="checkbox"/> L9300 Test Lead (p.35) 
	<input type="checkbox"/> LR6 Alkaline battery ×3 
	<input type="checkbox"/> Instruction Manual (this document)  Please visit Hioki's website to download other language versions in PDF format.
	<input type="checkbox"/> Operating Precautions (0990A907) 

Options

The options listed as follows are available for the instrument. To order an option, please contact your authorized Hioki distributor or reseller. Options are subject to change. Please check Hioki's website for the latest information.

Connection cables

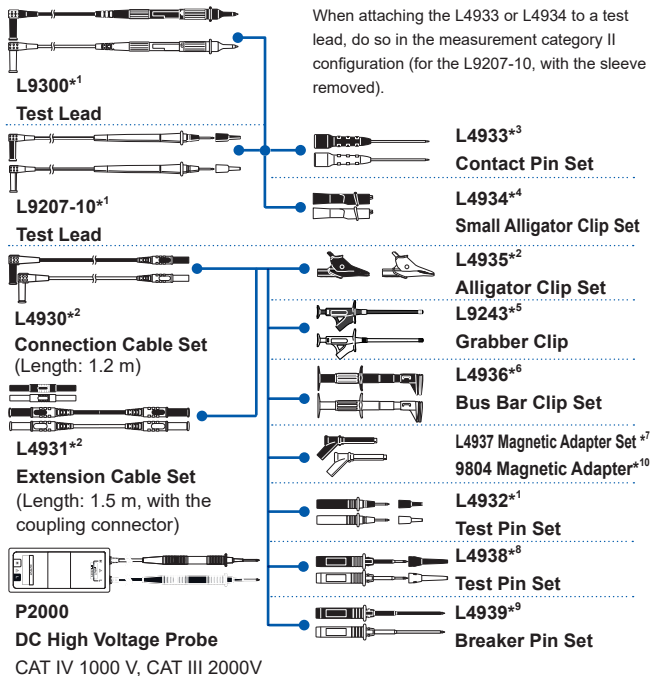

*1: CAT IV 600 V, CAT III 1000 V, CAT II 1000 V, 10 A

*2: CAT IV 600 V, CAT III 1000 V, 10 A

*3: 30 V AC, 60 V DC, 3 A

*4: CAT III 300 V, CAT II 600 V, 3 A

*5: CAT II 1000 V, 1 A

*6: CAT III 600 V, 5 A

*7: CAT III 1000 V, 2 A

*8: CAT III 600 V, CAT II 600 V, 10 A

*9: CAT III 600 V, 10 A

*10: CAT IV 1000 V, 2 A

For current measurement (p.71)



9704

9010-50, 9018-50, 9132-50

Conversion Adapter

Clamp on Probe (CAT III 600 V)

Clamp on Probe	Rated current	Measurable diameter of conductors
9010-50, 9018-50	500 A rms	46 mm or less in diameter
9132-50	1000 A rms	55 mm or less in diameter, 80 × 20 mm bus-bar

Carrying case

The instrument, test leads, instruction manual, and others can be stored.

C0202 Carrying Case



C0207 Carrying Case

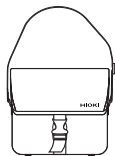

Magnetic strap (p.45)

Attach this strap to the instrument and secure it on the wall surface such as a metal plate for use.



Z5004 Magnetic Strap

Z5020 Magnetic Strap (Extra strength)

DT4900-01 Communication Package (USB) (p.93)



A communication adapter, USB cable, PC software, and communication specifications are included.



The instrument data can be stored on the PC.

Z3210 Wireless Adapter (p.41, p.96)









With this adapter installed to the instrument, the wireless communications function can be used.







Notations

Safety notations



In this document, the severity levels of risk and hazard are classified as follows.

 DANGER	Indicates an imminently hazardous situation that, if not avoided, will result in death or serious injury.
 WARNING	Indicates a potentially hazardous situation that, if not avoided, could result in death or serious injury.
 CAUTION	Indicates a potentially hazardous situation that, if not avoided, could result in minor or moderate injury.
NOTICE	Indicates potential risks of damage to the supported product (or to other property).
IMPORTANT	Indicates information or content that is particularly important from the stand point of operating or maintaining the instrument.
	Indicates a high-voltage hazard. Failure to verify safety or improper handling of the instrument could lead to an electric shock, burn, or death.
	Indicates the presence of a hazard caused by a strong magnet. The product could interfere with the proper operation of electronic medical devices such as pacemakers.
	Indicates a prohibited action.
	Indicates a mandatory action.

Symbols shown on the instrument

	Indicates the presence of a potential hazard. For more information about locations where this symbol appears on instrument components, see the section “Precautions for Use” (p. 13), warning messages listed at the beginning of operating instructions, and the accompanying document entitled “Operating Precautions.”
	Indicates a terminal that generates hazardous voltage.
	Indicates an instrument that has been protected throughout by double insulation or reinforced insulation.
	Indicates a fuse.
	Indicates a grounding terminal.
	Indicates DC (Direct Current).
	Indicates AC (Alternating Current).

Symbols for various standards

	Indicates that the product is subject to the Waste Electrical and Electronic Equipment (WEEE) Directive in EU member nations. Dispose of the product in accordance with local regulations.
	Indicates that the product complies with standards imposed by EU directives.

Screen display

The instrument screen displays the alphanumeric characters as follows.

A	B	C	D	E	F	G	H	I	J	K	L	M	N	O	P	Q	R	S	T	U	V	W	X	Y	Z
A	b	C	d	E	F	G	H	I	J	K	L	M	N	O	P	Q	R	S	T	U	V	W	X	Y	Z

1	2	3	4	5	6	7	8	9	0
1	2	3	4	5	6	7	8	9	0

A different display is used in the case below (when fuse is blown).

FUSE
OPEN

Accuracy

Hioki expresses accuracy as error limit values specified in terms of percentages of reading and digits.

Reading (display value)	Indicates the value displayed by the instrument. Limit values for reading errors are expressed as a percentage of the reading (“% of reading” or “% rdg”).
Digit (resolution)	Indicates the minimum display unit (in other words, the smallest digit that can have a value of 1) for a digital measuring instrument. Limit values for digit errors are expressed using digits.

Other notations

Tips	Indicates useful advice concerning instrument performance and operation.
[APS]	Names of user interface elements on the screen are enclosed in brackets ([]).
RANGE	Operation key names are highlighted in bold.
(p.)	Indicates the page number to reference.
*	Indicates additional information is described below.

Safety Information

This instrument is designed to conform to IEC 61010 Safety Standards and has been thoroughly tested for safety prior to shipment. However, using the instrument in a way not described in this manual may negate the provided safety features. Carefully read the following safety notes before using the instrument.

DANGER

- **Familiarize yourself with the instructions and precautions in this manual before use.**



Failure to do so could cause improper use of the instrument, resulting in serious bodily injury or damage to the instrument.

WARNING

- **If you have not used any electrical measuring instruments before, you should be supervised by a technician who has experience in electrical measurement.**

Failure to do so could cause the user to experience an electric shock.

Moreover, it could cause serious events such as heat generation, fire, and an arc flash due to a short-circuit.



Protective gear

- **Use appropriate protective insulation.**

Performing measurement using this instrument involves live-line work. Failure to use protective gear could cause the operator to experience an electric shock.

Using protective gear is prescribed under applicable laws and regulations.

Measurement categories

To ensure safe operation of measuring instruments, IEC 61010 specifies the measurement categories, which classifies testing and measuring circuits into three categories according to the types of mains circuits to which they are intended to be connected.

DANGER

- **Do not use a measuring instrument for measurements on a mains circuit that exceeds the range of the measurement category rated for the instrument.**



- **Do not use a measuring instrument without a measurement category rating for measurements on a mains circuit.**

Failure to observe this can cause a serious bodily injury and damage to the instrument and other equipment.

This instrument conforms to the safety requirements for CAT III 1000 V, CAT IV 600 V measuring instruments.

Measurement category II (CAT II)

Applicable to test and measuring circuits connected directly to utilization points (socket outlets and similar points) of the low-voltage mains installation.

EXAMPLE: Measurements on household appliances, portable tools, and similar equipment, and on the consumer side only of socket-outlets in the fixed installation.

Measurement category III (CAT III)

Applicable to test and measuring circuits connected to the distribution part of the building's low-voltage mains installation.

EXAMPLE: Measurements on distribution boards (including secondary meters), photovoltaic panels, circuit breakers, wiring, including cables, bus-bars, junction boxes, switches, socket-outlets in the fixed installation, and equipment for industrial use and some other equipment such as stationary motors with permanent connection to the fixed installation.

Measurement category IV (CAT IV)

Applicable to test and measuring circuits connected at the source of the building's low-voltage mains installation.

EXAMPLE: Measurements on devices installed before the main fuse or circuit breaker in the building installation.

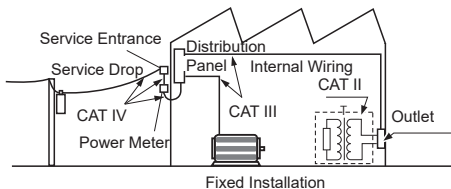

See: "2.3 Use of Test Leads" (p. 35)

Precautions for Use

Observe the following precautionary information to ensure that the instrument can be used safely and in a manner that allows it to perform as described in its specifications.

DANGER

- **Inspect the instrument and verify proper operation before use.**

Use of the instrument while malfunctioning could result in serious bodily injury. If you find any damage, contact your authorized Hioki distributor or reseller.



- **Before use, verify that test lead insulation is not torn and that no metal is exposed.**

Using test leads or an instrument that is damaged could result in serious bodily injury. If you discover any damage, replace with replace with a Hioki-specified part.

Installation

WARNING

■ **Do not install the instrument in locations such as the following:**

- In locations where it would be subject to direct sunlight or high temperatures
- In locations where it would be exposed to corrosive or explosive gases
- In locations where it would be exposed to powerful electromagnetic radiation or close to objects carrying an electric charge
- Close to inductive heating devices (high-frequency inductive heating devices, IH cooktops, etc.)
- In locations characterized by a large amount of mechanical vibration
- In locations where it would be exposed to water, oil, chemicals, or solvents
- In locations where it would be exposed to high humidity or condensation
- In locations with an excessive amount of dust or metal particles



Doing so could damage the instrument or cause it to malfunction, resulting in bodily injury.

Handling

NOTICE



- **Do not subject the product to vibration or mechanical shock while transporting or handling it.**
- **Do not drop the instrument.**

Doing so could damage the product.

Turn the rotary switch to OFF after use. A small amount of battery power is used in sleep mode in the auto power save function.

Precautions during measurement

DANGER

- **Do not short-circuit the two measurement lines with the metal portion of the test lead tips or cables.**

Doing so can cause arc flash, resulting in serious bodily injury or damage to the instrument or other equipment.

- **Never touch the metal portion of the test lead tips or cables during measurement.**

Doing so could cause serious bodily injury or a short-circuit.



- **Do not touch any input terminals on the VT (PT), CT or the instrument when they are in operation.**

Doing so could cause serious bodily injury.

- **Do not input voltage to the resistance measurement input terminal or the resistance measurement, continuity check, diode test, or capacitor function.**

Doing so could damage the instrument, resulting in bodily injury.

 **WARNING**

- **Do not use the instrument to measure circuits that exceed the ratings or specifications of the instrument.**

Doing so could cause damage to the instrument or overheating, resulting in bodily injury.

- **When using the instrument with the optional connection cables connected, do not attempt measurements that exceed the lower of the ratings noted on the components.**



Using the instrument to make measurements that exceed either rating could cause the user to experience an electric shock.

- **Do not input a current or voltage that exceeds the selected measurement range.**

Doing so could cause damage to the instrument, resulting in bodily injury.

- **Do not touch any terminal even when the shutter is closed.**

The terminals do not incorporate sufficient safe insulating distance, even when the shutter is closed. Doing so could cause electric shock.

-
- **When using the instrument, use only Hioki-specified test leads or options.**



Using test leads and options other than those specified could cause bodily injury or a short circuit accidents.

For continuity check, diode test, and measurement of resistance or electrostatic capacity

NOTICE

- **Before performing measurement, verify that the current and voltage of the measurement signal do not exceed the rating of the object to be measured.**



See: Measurement current and open circuit voltage in the accuracy table (p. 121)

Applying a signal that exceeds the rating could damage the object to be measured.

If the instrument is not to be used for an extended period of time

NOTICE

- **Remove the battery if the instrument will not be used for an extended period of time.**



Failure to do so may cause the battery to leak, damaging the instrument.

1.1 Overview and Features

This measuring instrument is a multi-function digital multimeter that ensures both safety and durability.

Main features and functions

- Speedy display of the RMS measured value
- High noise-proof performance
- Filter function (FILTER) that reduces the influence of noise
- Maximum/minimum/average display
- Environmental resistance performance (can be used anywhere)
- Solid body which can be used for an extended period of time (drop-proof)
- Not damaged by rain (IP54)
- Short circuit accidents prevented by the terminal shutter

Hazard indicated by the backlight (red) due to excessive input

(p. 28)

Problem finding a suitable installation location?

The magnetic strap allows the instrument to be hung conveniently.
(p.45)

**Using a smartphone, measurement data can be recorded, and current and voltage harmonics can be measured**

The Z3210 Wireless Adapter (option) is required.
(p. 96)

**Large, easily-viewable display**

Backlighting to allow users to read the measured values in dark environments

**Supplied test lead**

The measurement category can be switched by sliding the protective finger guard. (p. 36)

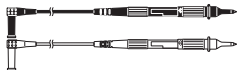







1.2 Part Names and Functions

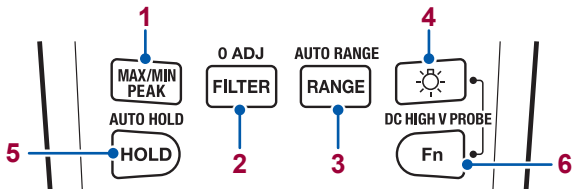







Front



Operation keys



		Press	Press for at least 1 second.	Power-on option (p.103)
1		Specifies/switches the display of the maximum, minimum, average, and peak values.	Cancels the display of the maximum, minimum, average, and peak values.	Enables/disables the DC voltage positive/negative judgment function.
2	0 ADJ 	Specifies/switches/cancels the passband of the low pass filter.	Zero adjustment	Buzzer sound ON/OFF
3	AUTO RANGE 	Sets the range to manual/switches the range, and sets to the clamp current range.	Sets the range to auto.	<ul style="list-style-type: none"> • Displays all LCD segments. • Displays the software version. • Displays the model number. • Displays the serial number. • Checks the HID settings. (Only when the Z3210 is installed)
4		Turns on/off the display backlight.	Specifies/cancels the wireless communications function. (Only when the Z3210 is installed)	Enables/disables the automatic deactivation function of the display backlight.
5	AUTO HOLD 	Specifies/cancels the hold function.	Specifies/cancels the auto holding function.	Disables the auto power save function (APS).
6		Switches the measurement items.	–	Enables/disables the user settings retention function.

		Press	Press for at least 1 second.	Power-on option (p.103)
1 + 4	 + 	–	Displays the number of events recorded using the event recording function.	–
1 + 6	 + 	–	–	Specifies/cancels the simultaneous display function of the maximum and minimum values.
3 + 6	 + 	–	–	ON/OFF of the HID function. (Only when the Z3210 is installed)
4 + 6	 + DC HIGH V PROBE 	–	Specifies/cancels DC High V Probe mode* * Used when the DC high voltage probe is connected.	–

Rotary switch and measurement function

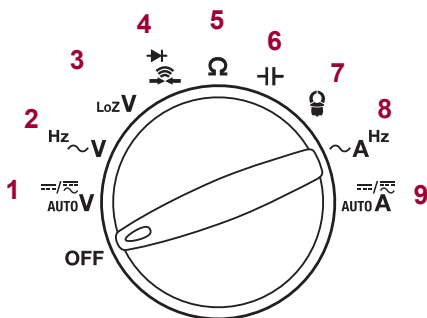

	OFF	Turns OFF the power to the instrument.
1	AUTO V	AC/DC voltage measurement (automatic judgment), DC voltage measurement, AC+DC voltage measurement (Input impedance 10 MΩ or more)
2	Hz ~ V	AC voltage measurement, frequency measurement
3	LoZ V	AC/DC voltage measurement (automatic judgment) (Input impedance 1.0 MΩ ±20%)
4		Continuity check, diode test
5	Ω	Resistance measurement
6		Electrostatic capacity measurement
7		AC current measurement (with clamp sensor)
8	~ A Hz	AC current (A) measurement, frequency measurement
9	AUTO A	AC/DC current measurement (automatic judgment), DC current measurement, AC+DC current measurement

Measurement terminals



1	Current measurement terminal (A terminal). The red test lead is connected. Setting the rotary switch to the current measurement opens the shutter.
2	Commonly used for each measurement. Hereafter referred to as “COM terminal”. The black test lead is connected.
3	Used for voltage measurement, resistance measurement, continuity check, diode test, electrostatic capacity measurement, or clamp current measurement. Hereafter referred to as “V terminal”. The red test lead is connected. Setting the rotary switch to any of the above measurements closes the current measurement terminal.

Be sure to carefully read the following precautions for the terminals with the  marking.

- “Precautions during measurement” (p. 16)
- “6.4 Fuse Replacement” (p. 142)

Rear

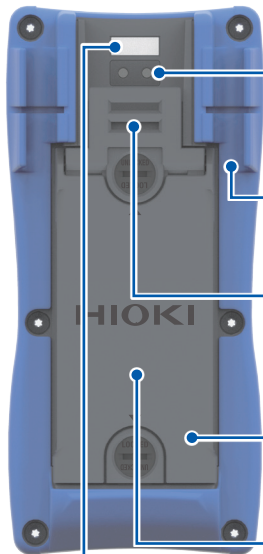
**Communication port**

When the communication adapter supplied with the DT4900-01 Communication Package (option) is attached, the data can be transmitted to the PC. (p.93)

Test lead holder

The test lead can be held.

Strap holes (rear)

The Z5004 or Z5020 Magnetic Strap (option) can be attached. (p.45)

Stand

The instrument can be used with the stand. (p.44)

Battery cover

The cover is removed to replace the batteries (p.30) or fuse (p.142) and to install the Z3210 Wireless Adapter (option) (p.41).

Serial number

The serial number consists of 9-digit numbers.
The first four digits indicate the year (its first two digits omitted) and the month of manufacture.
Do not remove this label as the number is important.

Gasket

(p.34, p.43, and p.145)
When the gasket (waterproof seal) attached to the battery cover shows signs of deterioration it needs to be replaced.
Contact your authorized Hioki distributor or reseller.

Bottom

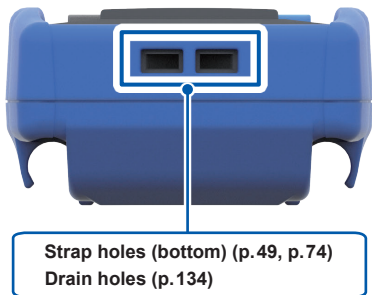

Display

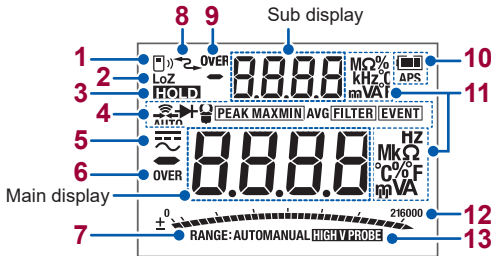

1		Wireless communications function (p.96)	7	RANGE: AUTOMANUAL	Auto range, manual range (p.77)
2	LoZ	Low input impedance measurement (p.61)	8		Communicating with the PC (p.93)
3	HOLD	Retention of the measured value (p.79)	9	OVER	The measured value in the sub display exceeds the maximum value of the range.
4		Continuity check (p.63)	10		Battery indicator (p.28)
	AUTO	AC/DC automatic judgment	11	APS	Auto power save function enabled (p.91)
		Diode test (p.64)		Each unit	
		Clamp current measurement (p.71)	12		Indication (example): In the case of 30.00 V input in the 60.00 V range, the bar is displayed to the center of the scale.
	PEAK MAXMIN AVG (p.86)	Maximum value (MAX), minimum value (MIN), average value (AVG), maximum value of the peak value (PEAK MAX), minimum value of the peak value (PEAK MIN)		HIGH V PROBE	DC High V Probe mode* enabled (p.73)
	FILTER	Filter function enabled (p.83)		13	
	EVENT	Event recording function (p.98)			
5		AC, DC	For details about the error, see "6.3 Error and Operation Display" (p.141).		
6	OVER	The measured value in the main display exceeds the maximum value of the range.			

1.3 Alarm Display and Battery Indicator

When the measured value exceeds the maximum input range in each range



Voltage/Current measurement

The measured value and **[OVER]** blink.
The backlight lights up in red.

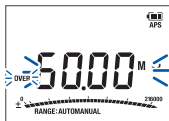

Measurement other than voltage and current

The measured value and **[OVER]** blink.

Corrective action:

If the input exceeds the maximum rating, the backlight blinks in red and an intermittent buzzer sounds as a warning. Immediately move the test leads away from the object under measurement.

Battery warning indicator

	Lights up	Fully charged.
	Lights up	As the battery charge diminishes, black charge bars disappear, one by one, from the left of the battery indicator.
	Lights up	The battery voltage is low. Replace the batteries as soon as possible.
	Blinks	The battery is exhausted. Replace with new batteries.

The charge is only a reference for the continuous operation time.

Power shutdown



When the battery charge is 0% (less than 3.0 V ± 0.1 V), **[bAtt]** in the display blinks for 3 seconds and the power is shut down.

2

Preparing for Measurements

2.1 Measurement Procedure

Before using the instrument, be sure to read “Precautions for Use” (p. 13).

Installation and connection

Insert batteries (p.30).

As necessary, have other optional items available and ready.

Perform inspection before use (p.51).

Measurement

Turn the power on and select the measurement function.

To use the instrument safely, be sure to select a measurement function before connecting the test leads to the object to be measured.

Connect the test leads to the measurement terminals (p.35).

As necessary, perform zero adjustment (p.88).

Connect the test leads to the object to be measured.

(As necessary)

Retain the measured value (p.79).

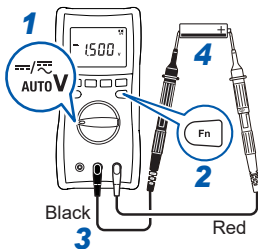

End

Move the test leads away from the object under measurement and then turn off the power.

2.2 Inserting/Replacing Batteries

Before using the instrument first time, insert three LR6 alkaline batteries.

See: "Battery installation/replacement procedure" (p.33)

Before measurements, check that the battery level is sufficient.

When the battery charge is low, replace the batteries.

See: "Battery warning indicator" (p.28)

WARNING

- **Before removing the battery cover, disconnect the instrument from the object under measurement and set the rotary switch to OFF.**



Failure to do so could cause electric shock. When the instrument is connected to the object under measurement, the battery contacts are regarded as high-voltage parts.

-
- **Do not short-circuit the battery.**
 - **Do not charge the battery.**
 -  ■ **Do not disassemble the battery.**
 - **Do not throw the battery into a fire.**

Doing so can cause the battery to explode, resulting in bodily injury.

WARNING

- **After replacing the batteries, attach and then lock the battery cover.**



Using the instrument with the cover removed could result in bodily injury.

Besides, the cover cannot be secured unless it is locked.

NOTICE

- **Do not mix batteries of different ages or types.**
- **Do not use a battery whose recommended service life has expired.**



- **Do not reverse the battery polarity.**
- **Do not leave the exhausted batteries in the instrument.**

Doing so may cause the battery to leak, damaging the instrument.

- **Use the specified batteries (LR6 Alkaline battery).**



- **Remove the batteries when the instrument is not in use for an extended period of time.**

Failure to do so may cause the battery to leak, damaging the instrument.

- The “” indicator lights up when battery voltage becomes low. Replace the batteries as soon as possible.
- Before replacing the batteries, make sure that the rotary switch is OFF.
- Handle and dispose of batteries in accordance with local regulations.

- The operating temperature range of the batteries provided with the instrument at the time of shipment is between -10°C and 45°C . When using the instrument outside of the specified temperature range, use batteries that are compatible with the operating temperature.

Battery installation/replacement procedure

Read the precautions before performing the procedure. (p.30)

You will need

- Phillips screwdriver (No. 2), flat-head screwdriver or coin
- LR6 Alkaline battery ×3

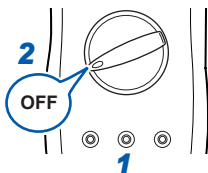

- 1 Remove the test leads from the instrument.
- 2 Set the rotary switch to OFF.

3 Release the locks for the battery cover.

Turn the locks 180° in the counterclockwise direction using the screwdriver or coin to align **[UNLOCKED]** with the ▲ symbol (2 places).

Rear

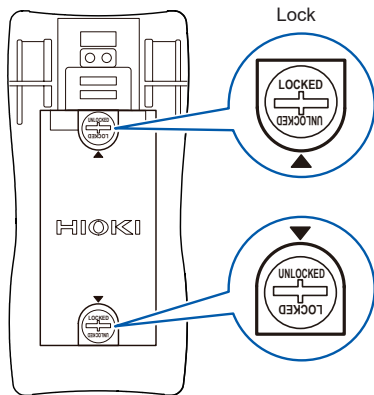

Continued to the next page →

4 Remove the battery cover.

Do not remove the gasket (waterproof seal) from the battery cover. (p.25)

5 Remove the batteries (when replacing them).

6 Insert new batteries, being careful to match the battery polarity.

Go to step 5 on p.43 when installing the Z3210 Wireless Adapter.

7 Reattach the battery cover.

8 Lock the battery cover.

Turn the locks 180° in the clockwise direction using the screwdriver or coin and align **[LOCKED]** with the ▲ symbol (2 places).

If the cover is not attached properly, the waterproof and dust-proof performance cannot be maintained.

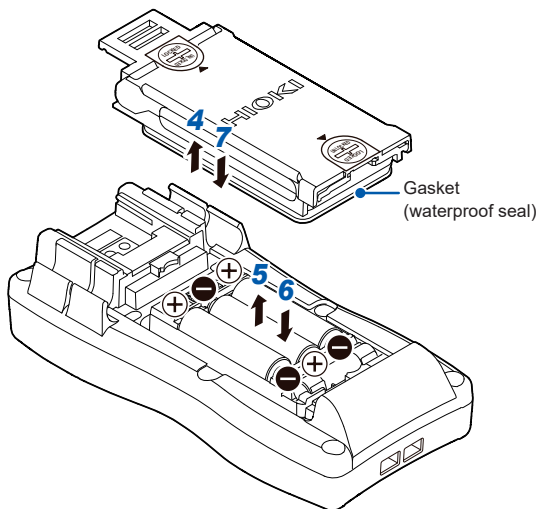

After the battery cover is removed, the fuse can be seen. For details about how to replace the fuse, see p. 142.

2.3 Use of Test Leads

The L9300 Test Lead (accessory) or the L9207-10 Test Lead (option) is used for measurement.

Depending on measurement locations, use our optional measurement cables.

See: "Options" (p.2)

WARNING

- **When using the instrument, use the test leads and options specified by Hioki.**



Using test leads and options other than those specified could cause bodily injury or short circuit accidents.

- **When measuring the power line voltage, use test leads that satisfy the following conditions.**



- IEC 61010 or EN 61010 safety standard-compliant
- Rated for measurement category III or IV
- Rated voltage higher than voltage being measured

Failure to do so may cause electric shock.

The optional test leads for this instrument comply with the EN 61010 safety standard. Observe the measurement category and rated voltage indicated on the test leads during use.

CAUTION

- **Do not step on cords or allow them to caught between other objects.**

Doing so may damage insulation, resulting in electric shock.

- **Do not touch the tips of test leads.**



The tips of test leads are sharp and could injure the user.

- **Do not bend or pull on cables at temperatures of 0°C or lower.**

Since cables become rigid, doing so could damage the insulation or cause a wire break, resulting in electric shock.

L9300 Test Lead (accessory)

See the precautions in “2.3 Use of Test Leads” (p.35) as well.

WARNING

- **Use the test leads with the correct measurement category displayed.**



- **Do not use the test leads if the metal pin is bent or the protective finger guard does not slide properly.**

Doing so could cause short circuit accidents.

Appearance of the L9300

For measurement in category III, IV

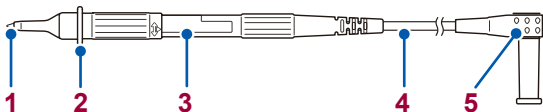

For measurement in category II

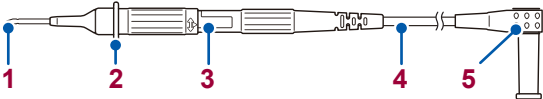

See: "Measurement categories" (p. 11)

1	Metal pin	Connected to the object to be measured For measurement in category III, IV: 4 mm or less For measurement in category II: 19 mm or less Diameter: Approx. 2 mm
2	Protective finger guard	Protects the user from hazardous voltage. Do not touch the area toward the end from the protective finger guard during measurement.
3	Measurement category display	The measurement category display changes when the protective finger guard is slid. Use the test leads with the correct measurement category displayed.
4	Cable	Double sheathed cables (Length: approx. 955 mm, diameter: approx. 3.6 mm) When the white portion inside the cable is exposed, replace the test lead with a new L9300.
5	Plug	Connected to the measurement terminals on this instrument. (p. 24) Protective sleeves are provided. Remove them before use.

Changing the measurement category

1 Unlock the protective finger guard.

Unlock by rotating to align the ▷ mark with the guide line.

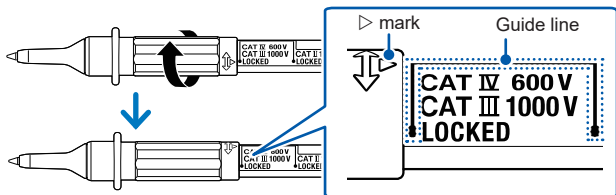

2 Slide the protective finger guard.

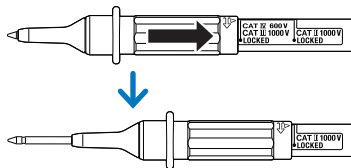

Slide the ▷ mark along the guide line.

3 Lock the protective finger guard.

Lock by rotating to align the ▷ mark with the guide line.

Rotate it until you hear a sound and make sure that the ▷ mark is pointing at **[LOCKED]**.

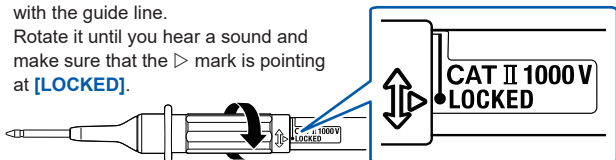

Perform the above steps to change from measurement category II to measurement category III or IV as well.

L9207-10 Test Lead (option)

See the precautions in “2.3 Use of Test Leads” (p.35) as well.

WARNING

- **Attach the sleeves to the test leads when performing category III (CAT III) or IV (CAT IV) measurement.**



- **Stop the measurement if the sleeves come off during measurement.**

Failure to do so could cause electric shock.

See: “Measurement categories” (p. 11)

CAUTION

- **When using the test leads with the sleeves attached, verify that the sleeves are free of damage.**



Performing measurement with a damaged sleeve attached could cause the user to experience electric shock.

Appearance of the L9207-10

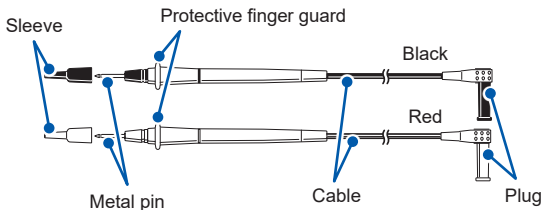

Sleeve	Attached to the metal pin to prevent short circuit accidents.
Metal pin	Connected to the object to be measured. With sleeves attached: 4 mm or less Without sleeves attached: 19 mm or less Diameter: Approx. 2 mm
Protective finger guard	Protects the user from hazardous voltage. <div style="border: 1px solid black; padding: 5px; margin-top: 10px;">Do not touch the area toward the end from the protective finger guard during measurement.</div>
Cable	Double sheathed cables (Length: approx. 900 mm, diameter: approx. 3.6 mm) <div style="border: 1px solid black; padding: 5px; margin-top: 10px;">When the white portion inside the cable is exposed, replace the test lead with a new L9207-10.</div>
Plug	Connected to the measurement terminals on this instrument. (p. 24) Protective sleeves are provided. Remove them before use.

Removing the sleeves

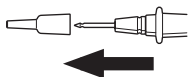

Grip the base of the sleeves and pull the sleeves off.
Store removed sleeves for future use.

Attaching the sleeves

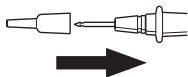

Insert the metal pins of the test leads into the holes of the sleeves, and firmly push them all the way in.

2.4 Installing Wireless Adapter

When the Z3210 Wireless Adapter (option) is installed to the instrument, the wireless communications function can be used. (p.96)

WARNING

- **Before removing the battery cover, disconnect the instrument from the object under measurement and set the rotary switch to OFF.**



Failure to do so could cause electric shock. When the instrument is connected to the object under measurement, the battery contacts are regarded as high-voltage parts.

- **After installing or removing the Z3210 Wireless Adapter, attach and then lock the battery cover.**



Using the instrument with the cover removed could result in bodily injury.
Besides, the cover cannot be secured unless it is locked.

NOTICE

- **Before handling the Z3210, touch metal (a door knob, etc.) to discharge static electricity.**



Static electricity may damage the Z3210.

Z3210 Wireless Adapter installation procedure

Read the precautions before performing the procedure. (p.41)

You will need

- Phillips screwdriver (No. 2), flat-head screwdriver or coin
- Z3210 Wireless Adapter (option)

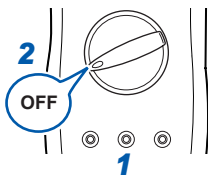

- 1** Remove the test leads from the instrument.
- 2** Set the rotary switch to OFF.

3 Release the locks for the battery cover.

Turn the locks 180° in the counterclockwise direction using the screwdriver or coin to align **[UNLOCKED]** with the ▲ symbol (2 places).

Rear

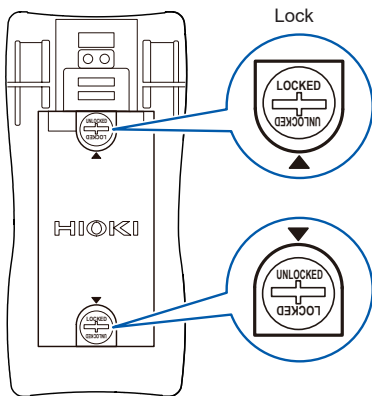

4 Remove the battery cover.

Do not remove the gasket (waterproof seal) from the battery cover. (p.25)

5 Remove the protective cap from the instrument.**6 Push in the Z3210 Wireless Adapter all the way making sure that the direction of the adapter is correct.****7 Reattach the battery cover.****8 Lock the battery cover.**

Turn the locks 180° in the clockwise direction using the screwdriver or coin and align **[LOCKED]** with the ▲ symbol (2 places).

If the cover is not attached properly, the waterproof and dust-proof performance cannot be maintained.

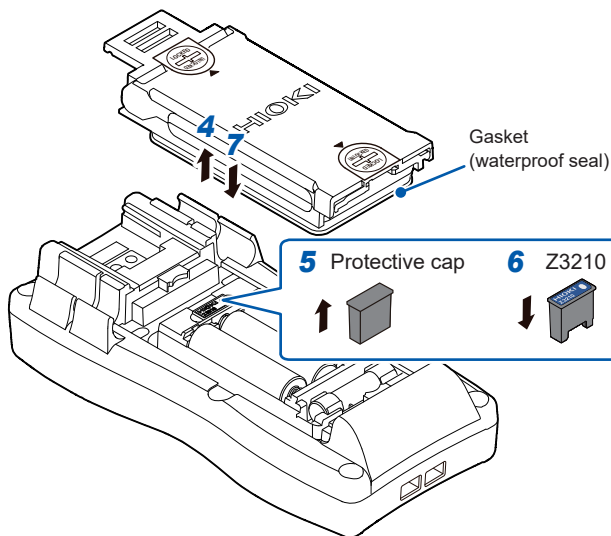

2.5 Instrument Installation in the Measurement Location

Using the instrument with the stand

Position the instrument with the stand at the rear.

CAUTION

- Do not place the instrument on an unstable stand or angled surface.



Doing so could cause the instrument to fall or overturn, resulting in bodily injury or damage to the instrument.

NOTICE

- Do not apply excessive force from above when utilizing the stand.



Doing so may damage the stand.

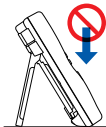

Using magnetic strap

Attach the Z5004 or Z5020 Magnetic Strap (option) to the instrument and attach the magnet to the wall surface (metal plate), etc.

DANGER

- **People with electronic medical devices such as pacemakers should not use the Z5004 or Z5020 Magnetic Strap.**



- **Keep the magnetic strap away from the body.**

The medical electronics may not operate properly and the life of the operator may be put at great risk.

WARNING

- **Keep the magnetic strap out of the reach of children.**



Magnets can be life-threatening if swallowed. If magnets are accidentally swallowed, immediately seek medical attention and follow the directions of the health authority.

NOTICE

- **Do not drop the magnetic strap onto a floor or other surface.**
- **Do not apply excessive force to the magnetic strap.**

Failure to do so may damage the magnetic strap.

- **Do not use the magnetic strap if it has been exposed to rainwater, dust, or condensation.**

Such exposure could cause the magnetic strap to corrode or otherwise degrade. Additionally, it could reduce the strength of the magnet, allowing the product to fall and sustain damage.



- **Keep the magnetic strap away from magnetic cards, prepaid cards, magnetized tickets, or other magnetic recording media.**
- **Keep the magnetic strap away from PCs, TV screens, electronic wrist watches, or other precision electronics devices.**

Failure to do so may damage the data and devices.

Magnetic strap attachment procedure

Read the precautions before performing the procedure. (p.45)

You will need

- Phillips screwdriver (No. 2), flat-head screwdriver or coin
- Z5004 or Z5020 Magnetic Strap (option)

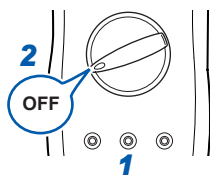

1 Remove the test leads from the instrument.

2 Set the rotary switch to OFF.

3 Release the locks for the battery cover.

Turn the locks 180° in the counterclockwise direction using the screwdriver or coin to align **[UNLOCKED]** with the ▲ symbol (2 places).

Rear

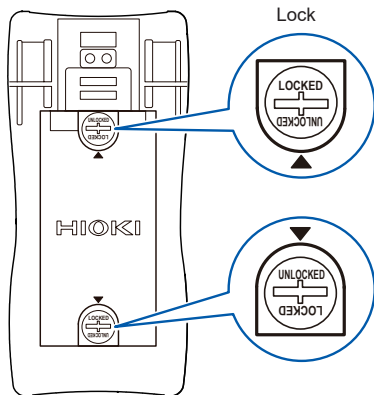

Lock

Continued to the next page →

- 4 Remove the battery cover.
- 5 Attach the magnetic strap through the strap holes of the battery cover.

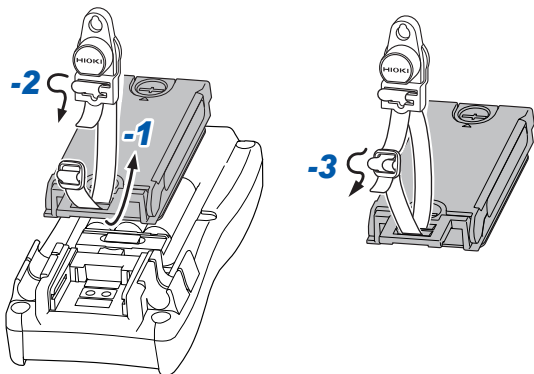

- 6 Reattach the battery cover.

- 7 Lock the battery cover.

Turn the locks 180° in the clockwise direction using the screwdriver or coin and align **[LOCKED]** with the ▲ symbol (2 places).

If the cover is not attached properly, the waterproof and dust-proof performance cannot be maintained.

- 8 Place the magnet on the wall surface (metal plate), etc.

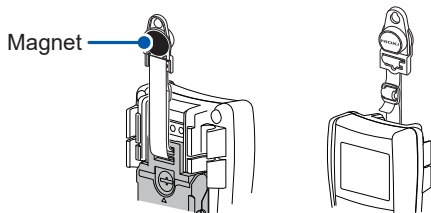

Strap attachment procedure

A strap can be attached to the instrument.

NOTICE

- **Securely attach the strap through the strap holes to the instrument.**



Failure to do so could cause the instrument to fall while being carried, resulting in damage.

2

Pass the strap through the strap holes (bottom) as shown below.

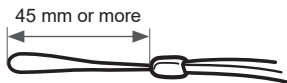
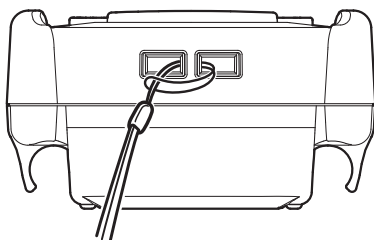

Loop type

- Use a strap with a loop length of 45 mm or more.
- When using the L4943 Connection Cable Set in DC High V Probe mode, connect the strap buckle to the instrument.
See: “3.10 DC High V Probe Mode” (p.73)

3.1 Inspecting the Instrument Before Use

DANGER

- **Inspect the instrument and verify proper operation before use.**

Use of the instrument while malfunctioning could result in serious bodily injury. If you find any damage, contact your authorized Hioki distributor or reseller.



- **Before using the instrument, check that the coating of the test leads are neither ripped nor torn and that no metal parts inside the test leads are exposed.**

Using the damaged test leads or instrument can result in serious bodily injury. If any damage is found, replace the test leads with those specified by Hioki.

IMPORTANT







When the instrument is returned from a high temperature/ high humid environment to a room temperature environment and condensation occurs, remove the battery cover, fuse, and batteries and then allow the instrument to dry at room temperature for 24 hours or longer. Otherwise, accurate measurement may not be performed.

Appearance check of the instrument and test leads

Visually check the instrument.

Check item	Action
<ul style="list-style-type: none"> The instrument is neither damaged nor cracked. The internal circuits are not exposed. 	If any damage is found, request repair. Otherwise, there is a risk of receiving an electric shock.
The terminals are not contaminated with debris.	Remove contamination with a cotton swab.
The coating of the test leads is neither broken nor frayed, or the white portion or metal part within the lead is not exposed.	If any damage is found, replace the test leads with those specified by Hioki. Otherwise, there is a risk of receiving an electric shock.

Check when the power is turned on

Check item	Action
The battery charge is sufficient.	When the battery indicator at the upper right of the display is  , the battery voltage is low. Replace the batteries as soon as possible. (p.33) The power may be turned off when the backlight lights up or a buzzer sounds.
The accuracy can be guaranteed until  blinks.	
Battery voltage (Error ± 0.1 V)	Display
4.0 V or more	 lights up
3.5 V to less than 4.0 V	 lights up
3.2 V to less than 3.5 V	 lights up
3.0 V to less than 3.2 V	 blinks
Less than 3.0 V	After [bAtt] blinks, the power is shut down.

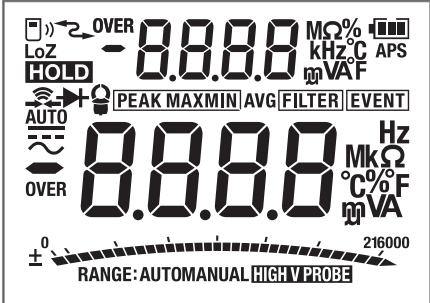
Check item	Action
<p>No display segments are missing. All the display segments are lit while the RANGE key is held down when the rotary switch is turned to [AUTO V] with the power OFF. (p.27)</p>	<p>If any of the display segments are missing, request repair.</p>
<p>Displaying all LCD segments</p> 	

Operation check

This section introduces some of the operation checks. Periodical calibration is necessary in order to ensure that this instrument operates according to its specifications.

1 Check that the protective finger guard for the L9300 Test Lead operates properly.

Check method	Action
<p>Follow the procedure in “Changing the measurement category” (p. 38) and check the operation of the protective finger guard.</p>	<p>Normal:</p> <ul style="list-style-type: none"> • The protective finger guard operates smoothly. • The grip makes a sound when it is locked. <p>Abnormal: The lock is easily released.</p> <p>Corrective action: There is a risk of receiving an electric shock. Replace with those specified by Hioki.</p>

2 Check that the test leads are not broken.

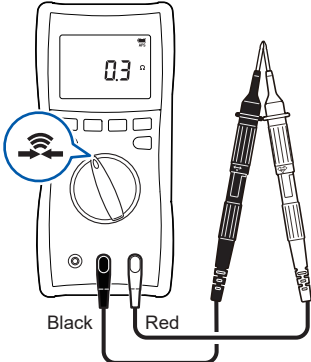
Check method	Action
<p>In the continuity check mode, deliberately short-circuit the test leads and then check the display.</p> 	<p>Normal: A buzzer sounds and the value stabilizes at around 0 Ω.</p> <p>Abnormal: A buzzer does not sound and a numeric value other than the above appears.</p> <p>Corrective action: The test leads may be broken. Replace with those specified by Hioki. If the same condition persists even after the test leads are replaced, a malfunction of the instrument may have occurred. Stop the inspection and then request repair.</p>

3

Continued to the next page →

3 Measure samples (such as battery, commercial power supply, and resistor) of which values have already been known, and check that the appropriate values appear.

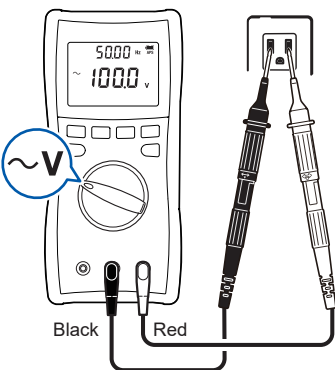
Check method	Action
<p>Example: Perform the AC voltage measurement to measure the commercial power supply, and then check the display.</p>  <p>The diagram shows a multimeter with its display showing two values: 5000 mV and ~1000 V. A callout bubble with a tilde and a 'V' symbol points to the AC voltage selector knob. The multimeter is connected to a wall outlet using black and red test leads. The black lead is labeled 'Black' and the red lead is labeled 'Red'.</p>	<p>Normal: An already-known value appears. (In this example, the commercial voltage level should appear.)</p> <p>Abnormal: The measured value does not appear.</p> <p>Corrective action: A malfunction may have occurred. Stop the inspection and then request repair.</p>

4 Check that the fuse is not blown.

Check method	Action				
1. Remove the fuse from the instrument (p. 142). 2. Reattach the battery cover. 3. In the resistance measurement, check the resistance of the fuse. See: Resistance measurement (p. 65)	<p>Normal:</p> <table border="1" data-bbox="523 278 923 365"> <thead> <tr> <th data-bbox="523 278 720 321">Fuse rating</th> <th data-bbox="720 278 923 321">Resistance</th> </tr> </thead> <tbody> <tr> <td data-bbox="523 321 720 365">11 A</td> <td data-bbox="720 321 923 365">1 Ω or less</td> </tr> </tbody> </table> <p>Abnormal: The value above is not obtained (the value higher than that is displayed).</p> <p>Corrective action: Replace the fuse. (p. 142)</p>	Fuse rating	Resistance	11 A	1 Ω or less
Fuse rating	Resistance				
11 A	1 Ω or less				

3

Before measurements

WARNING

- Check the position of the rotary switch before measurement.
- Remove the test leads from the object under measurement before changing the position of the rotary switch.



Failure to do so can cause serious bodily injury, short circuit, or damage to the instrument.

3.2 Voltage Measurement

AC voltage, DC voltage, and DC/AC composite voltage measurement can be performed. Additionally, the maximum, minimum, average, and peak values of the measured values can be checked. (p.86)

WARNING



- **Do not use the instrument to measure circuits that exceed the ratings or specifications of the instrument.**

Doing so could cause damage to the instrument or overheating, resulting in bodily injury.

- The autoranging function of the instrument automatically selects the optimum measurement range. To change the range arbitrarily, use the manual range (p.78).
- Displayed values can frequently fluctuate due to induction potential even when no voltage is applied. This, however, is not a malfunction.
- The 600 mV range is available only for DC voltage measurement.

Measuring DC voltage, AC voltage, and DC/AC composite voltage

Measure the DC voltage, AC voltage, or DC/AC composite voltage.
See: "4.8 DC Voltage Positive/Negative Judgment Function"
(p. 92)

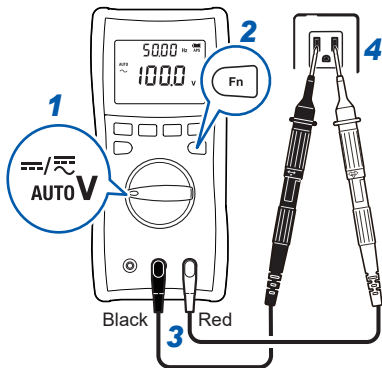

2  Switches the measurement items.

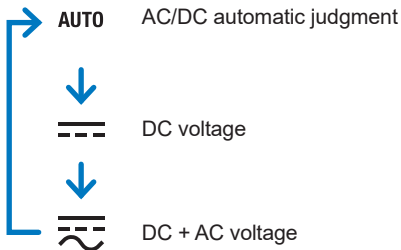

3

Measuring AC voltage

Measure the AC voltage. Measure the frequency simultaneously.
The measured value is a true RMS. (p. 147)

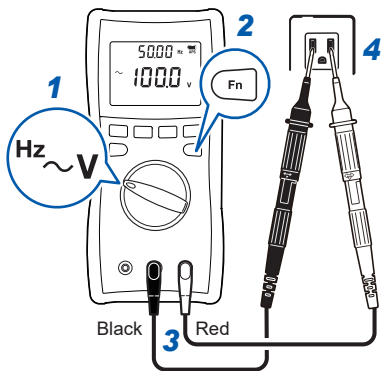

2  Switches the measurement items.

 AC voltage



Hz Frequency

Measuring voltage with low input impedance

Measure the voltage with $1\text{ M}\Omega$ input impedance to prevent false measurement due to stray voltage.

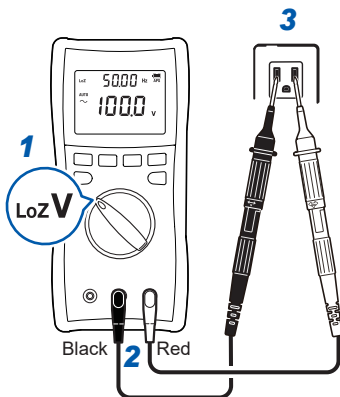

3

3.3 Frequency Measurement

During AC voltage measurement (p.60) and AC current measurement (p.69), the frequency can be checked in the sub display. The frequency display is autoranging. The AC voltage and current ranges can be changed by pressing the **RANGE** key.

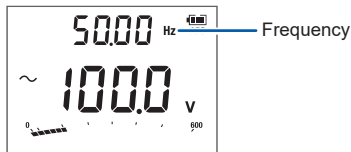

- If signals out of the range of frequency measurement are measured, [----] appears.
- In a measurement environment with a large amount of noise, the frequency may be displayed even with no input. This does not indicate a malfunction of the instrument.

Tips

- The sensitivity of the frequency measurement is regulated by range.
See: “5. Voltage frequency” (p. 120)
“13. Current frequency” (p. 127)
When the value is less than the minimum sensitivity voltage (minimum sensitivity current), the indicated value may fluctuate. When the voltage (current) range is lowered, the value stabilizes. This does not apply to cases where the value fluctuates due to noise.
- During the measurement of low frequency voltage (current), if the auto range does not stabilize and the frequency cannot be measured, fix the voltage (current) range and measure again.

3.4 Continuity Check

The input short circuit is detected and informed via a buzzer and red backlight.

! WARNING

- Turn off the power to the measuring circuit before performing measurement.



Failure to do so could cause electric shock or damage to the instrument.

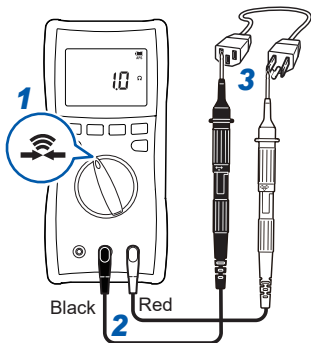

Detection	Threshold value	Buzzer sound	Red backlight
Short circuit detection	$25 \Omega \pm 10 \Omega$	Sounds (continuous buzzer sound)	Turns on
Open detection	$245 \Omega \pm 10 \Omega$	No	Turns off

3.5 Diode Voltage Measurement

The forward voltage of the diode is measured.

Forward voltage	Buzzer sound	Red backlight
0.15 V to 1.8 V	Intermittent	—
Less than 0.15 V	Continuous	Turns on

! WARNING



- Turn off the power to the measuring circuit before performing measurement.

Failure to do so could cause electric shock or damage to the instrument.

NOTICE

- Check the specifications of the object to be measured in advance.



Failure to do so could damage the object to be measured. The open terminal voltage is approximately 2.0 V DC or less.

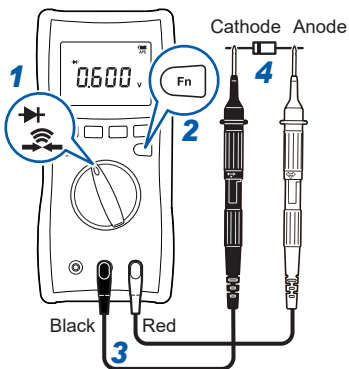

In the case of the opposite connection

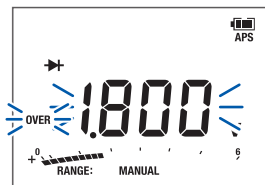

The measured value and **[OVER]** blink.

3.6 Resistance Measurement

Resistance is measured.

To measure the low resistance accurately, it is necessary to cancel the resistance of the test leads. Perform zero adjustment for the displayed value in advance. (p.88)

⚠ WARNING



- Turn off the power to the measuring circuit before performing measurement.

Failure to do so could cause electric shock or damage to the instrument.

3

NOTICE

- Check the specification of the object to be measured in advance.



Failure to do so could damage the object to be measured. The open terminal voltage is approximately 2.0 V DC or less.

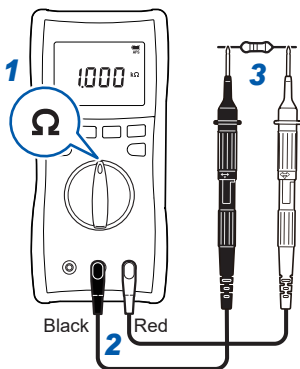

3.7 Electrostatic Capacity Measurement

The capacity of the capacitor is measured.

For components on a circuit board, measurement may not be possible due to the effect of the peripheral circuit.

WARNING

- **Turn off the power to the measuring circuit before performing measurement.**



Failure to do so could cause electric shock or damage the instrument.

-
- **Do not measure the capacitor which has been charged.**



Doing so can cause the capacitor to explode, resulting in bodily injury or damage to the instrument.

Also accurate measurement cannot be performed.

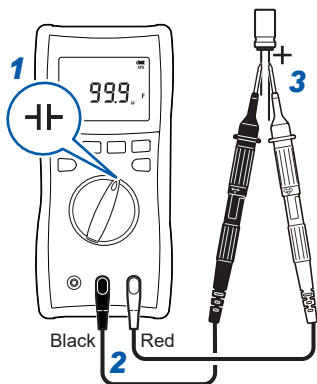
**Tips****When measuring the polar capacitor**

Connect the V terminal (red test lead) to the plus terminal of the capacitor and the COM terminal (black test lead) to the minus terminal.

3.8 Current Measurement

The DC current and AC current of 10 A or less is measured.

DANGER

- **Do not connect the instrument to a current transformer with no internal protection.**



This instrument is not designed to be connected to current transformer with no internal protection. Doing so could cause damage to the instrument, resulting in bodily injury.

- **Do not input any voltage to the current measurement terminals.**



- **Turn off the power to the measurement circuit before connecting or disconnecting the test leads.**

Failure to do so may lead to arc discharge, resulting in bodily injury.

WARNING

- **Do not input any voltage when the instrument is set to the current range.**



Doing so could cause damage to the instrument, resulting in bodily injury.

When [FUSE OPEN] is displayed

The fuse may have blown. Check whether the fuse has blown. (p. 57) If so, replace it. (p. 142)



When measuring an unknown current

Set the range to auto (the default setting) or 10 A.

Measuring AC current

Measure the AC current.

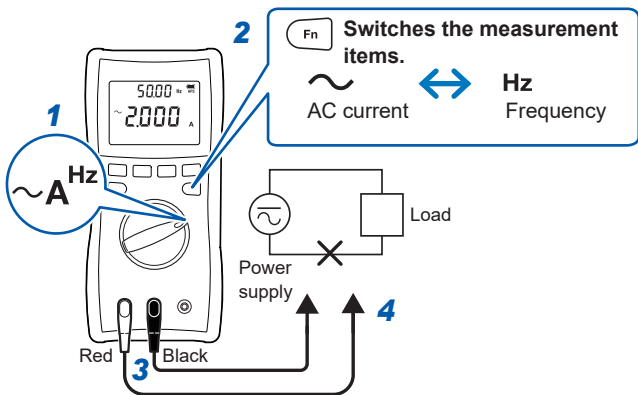

- Measurement is performed using DC coupling, and the AC component's RMS value is calculated in software and displayed.
- The bar graph displays RMS values for AC and DC components. Additionally, the GENNECT Cross waveform display shows waveforms for AC and DC components.

Measuring DC current/AC current

Measure the DC current or AC current.

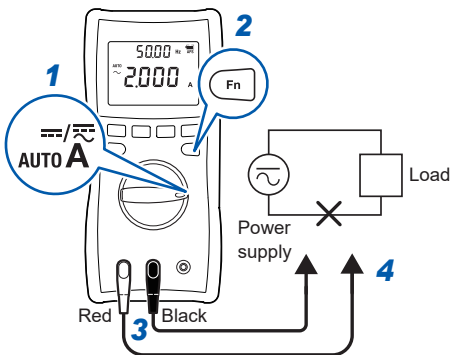

2 Switches the measurement items.

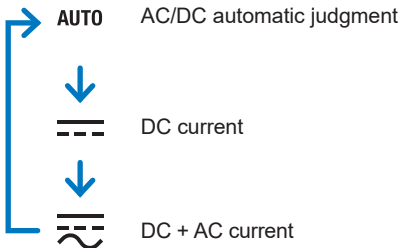

3.9 Measurement with Clamp On Probe (AC Current)

The current is measured using the Clamp on Probe (9010-50, 9018-50, 9132-50, option). To connect the Clamp on Probe to this instrument, the 9704 Conversion Adapter (option) is required. Before using the Clamp on Probe, be sure to read the Instruction Manual which accompanies the Clamp on Probe.

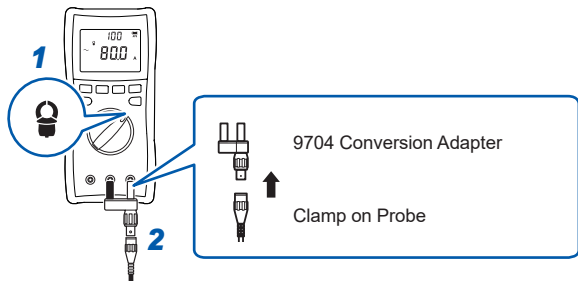

Set the Clamp on Probe and the instrument to the same range.

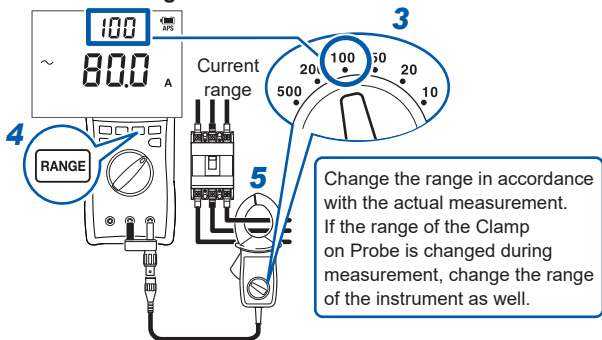

Continued to the next page →

When clamping a cable

IMPORTANT

Clamp the instrument around only one wire of the conductor. Regardless of the single-phase and three-phase, when clamping around two or more wires together in a bundle, the load current cannot be measured.



OK



Do not clamp the instrument around two or more conductors.

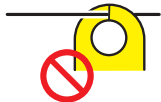

Do not pinch the conductor.

When the measured value and [OVER] blink

The measured value has exceeded the maximum display counts. Increase the range by one step.

3.10 DC High V Probe Mode

Use of the P2000 DC High Voltage Probe (optional) allows you to measure DC voltage of up to 2000 V (CAT III 2000 V, CAT IV 1000 V), such as open voltage of solar panels.

WARNING

■ Do not use the P2000 to measure AC voltages.

The probe cannot accurately measure AC voltages. Improper measurement could lead to electric shock.

You can use the P2000 for DC voltage measurement only.



■ Do not measure voltage that exceeds 2000 V DC.

Doing so could damage the instrument and the P2000, causing bodily injury.

■ Use the P2000 to measure voltage that exceeds 1000 V.

Use of other probes could cause the operator to experience an electric shock.



NOTICE

■ Connect the instrument and the P2000 together with the strap when using the L4943.

The cables and plugs will be subjected to stress, damaging them.



Preparation

When using the L4943 Connection Cable Set (comes with P2000)

- 1 Release the clip from the strap buckle (comes with P2000).

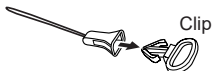

- 2 Attach the strap to the P2000.

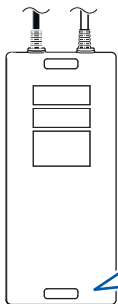
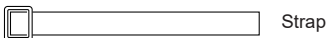

- 1 Pass the strap through the strap attachment hole on the back of the P2000.
- 2 Pass the strap through the clip.
- 3 Secure the strap as shown in the figure.

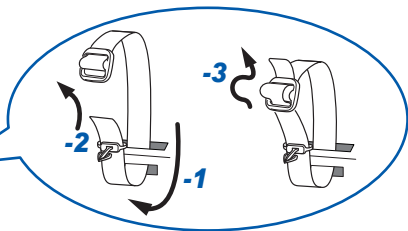

- 3 Attach the strap buckle to the strap holes (bottom) of the instrument and connect it to the clip that you attached to the P2000 with the strap.

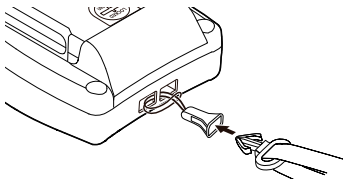

When using the L4930 Connection Cable Set or the L4931 Extension Cable Set (optional)

Hang the P2000 in some way, such as using a magnetic strap, not to subject the cables and the connectors to stress.

Making Measurements

(Default setting: OFF)

1 Rotate the rotary switch.



2 Hold down the two keys for 1 s as described below.

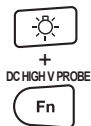

DC High V Probe mode ON
HIGH V PROBE Flash

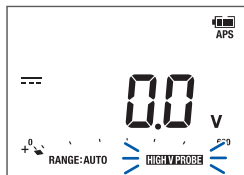

3 Connect the P2000 DC High Voltage Probe to the measurement terminals of the instrument.

Connect the instrument's COM and V terminals to the P2000's OUTPUT L (black) and OUTPUT H (red) terminals, respectively, with the L4943 or L4930.

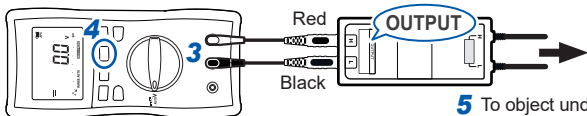

5 To object under measurement

4 Set the range.



5 Connect the P2000's probes to the object under measurement.

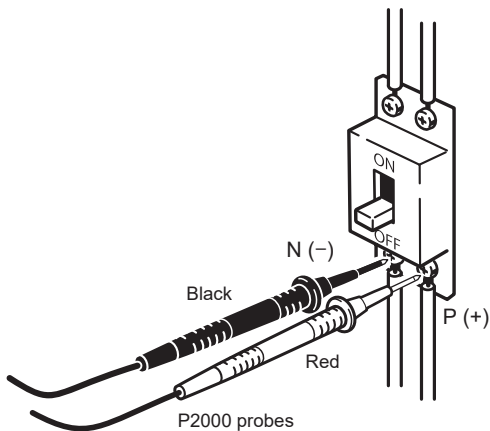

To store the DC High V Probe mode setting, enable the user setting retention function.

See: "User setting retention function enabled/disabled" (p. 107)

4.1 Measurement Range Selection

Auto or Manual range can be selected. In the case of measurement where the desired range can be selected, [RANGE:] lights up at the bottom of the display.

(Default setting: Auto range)

Measuring with the auto range

An optimum measurement range is automatically selected.

When the measurement function is switched using the rotary switch, the auto range is enabled.

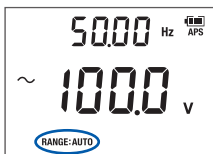

[RANGE: AUTO] lights up

Pressing **RANGE** during auto-range operation will switch to manual-range operation with the range fixed at the current setting.

Measuring with the manual range

A range is selected manually.



Press

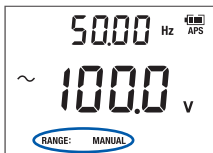

[RANGE: MANUAL] lights up

Each time **[RANGE]** is pressed, an upper range is specified.

When **[RANGE]** is pressed continuously, the range is switched to **[AUTO]** (auto range) after the highest range.

When **[RANGE]** is pressed during measurement at the highest range, the lowest range is specified once again.

Example: When the range is 6.000 V to 1000 V



Switching from the manual range to the auto range

Press **[RANGE]** for at least 1 second.

4.2 Hold Function (HOLD)

Retaining the measured value manually (HOLD)

Display update is stopped at a selected timing. (The bar graph is updated.)

(Default setting: OFF)

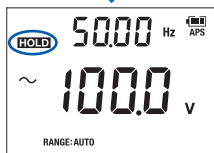

Press
(Press it again to cancel the hold function.)



Retention of the measured value.

Retaining the measured value automatically (AUTO HOLD)

Display update is automatically stopped once the measured value stabilizes. (The bar graph is updated.) (Default setting: OFF)

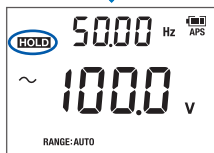

Press for at least 1 second.
(Press it for at least 1 second again to cancel the hold function.)

Before auto holding (Standby for the measured value to stabilize)



After auto holding

When the measured value stabilizes, a buzzer sounds and the measured value is retained.



Disconnect the test leads from the object under measurement.
Connect the test leads to the next object to be measured.

When the measured value stabilizes, a buzzer sounds and the new measured value is retained.



Press

Returns to the standby state for the measured value to stabilize.



- If the input signal is too small for the relevant range, the measured value cannot be automatically retained.
- The measured value will be automatically retained once it stabilizes within the stable range (which takes approx. 2 seconds).

Conceptual diagram (AC voltage)

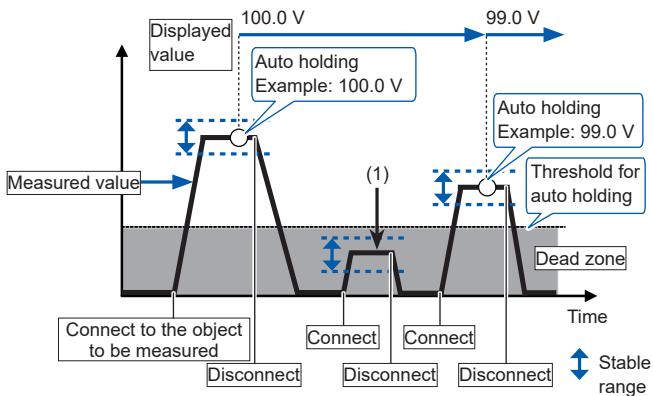

(1) Not retained automatically (the threshold is not exceeded).

Requirements for auto holding

When the following 2 requirements are met, display update is stopped.

- When the fluctuation width of the measured value stabilizes within the range shown in the following table
- When the measured value exceeds the threshold value shown in the following table (voltage, current) or the measured value falls below the threshold value in the following table (continuity check, resistance, diode test)

Measurement item*1	Range	Fluctuation range	Threshold value
AUTO V*2 DC voltage*2 AC + DC voltage AC voltage LoZ V DC high voltage (DC High V Probe mode)	Other than 1000 V	Within 120 counts	120 counts
	1000 V	Within 20 counts	20 counts
Continuity check Resistance	All ranges	Within 100 counts	4900 counts
Diode test	1.800 V	Within 40 counts	1460 counts
AC current (Clamp sensor)	10.00 A	Within 50 counts	50 counts
	20.00 A	Within 100 counts	100 counts
	50.0 A	Within 25 counts	25 counts
	100.0 A	Within 50 counts	50 counts
	200.0 A	Within 100 counts	100 counts
	500 A	Within 25 counts	25 counts
	1000 A	Within 50 counts	50 counts
AC current AUTO A DC current AC + DC current	Other than 10 A	Within 120 counts	120 counts
	10 A	Within 20 counts	20 counts

*1: Auto holding is not available for measurement items not shown.

*2: Auto holding is not available for the 600 mV range.

4.3 Filter Function (FILTER)

The influence of high-frequency noise can be reduced with the low-pass filter (digital filter). The filter function is useful for measurements such as standard waveform measurement (AC voltage measurement) of the inverter secondary side.

This function can be used when performing the AC voltage measurement, AC and DC voltage automatic judgment, AC current measurement, and clamp AC current measurement. The passband setting for the low pass filter can be selected.

WARNING

- **Select a proper passband setting when measuring the AC voltage.**



Using the instrument to make measurements with inappropriate settings could cause the user to fail to realize the presence of hazardous input, resulting in electric shock. Additionally, it could cause attenuation of signals in the band being measured, preventing the instrument from displaying accurate measured values.

Filter Function (FILTER)

(Default setting: OFF)



≡ **FILTER** ≡ lights up



≡ **FILTER** ≡ blinks

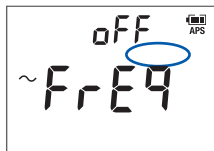

FILTER turns off

Press

Each time the key is pressed, the passband setting is changed.



When the desired passband setting is displayed for approximately 2 seconds, the setting is applied and then the measurement screen is displayed again.

Example of frequency characteristic when the filter is used

(AC voltage 600.0 V range, 100 V input)

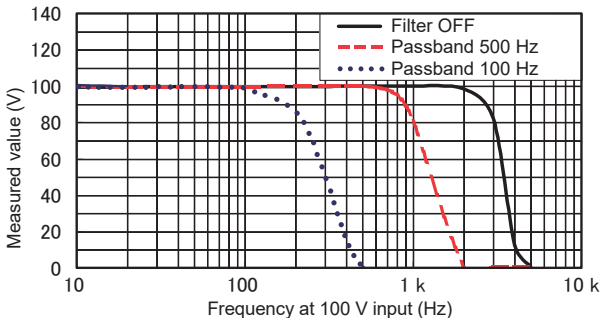

4

When measuring power supplies with a power frequency of 400 Hz, which is mainly used in ships and aircrafts

Set the FILTER to **[oFF]** or **[500 Hz]**.

If the FILTER is set to **[100 Hz]**, accurate measurement can not be performed.

4.4 Maximum, Minimum, Average, and Peak Values

Displaying MAX, MIN, AVG, PEAK MAX, and PEAK MIN in order

The maximum value (MAX), minimum value (MIN), average value (AVG), maximum value of the peak value (PEAK MAX), minimum value of the peak value (PEAK MIN) of the measured values can be checked. (Default setting: OFF)

- The display of the maximum, minimum, average, and peak values is disabled in the following functions.
 AUTO V, LoZ V, AUTO A, continuity check, and diode test
- When using auto range, the measurement range is fixed at the current setting.
- [APS] disappears and the auto power save function is disabled.
- When using the 6.000 V or lower range or the filter function enabled, the display will not switch to [PEAK MAX] or [PEAK MIN].



- 1 Connect the test leads to the object to be measured.
- 2 Press

Each time the key is pressed, the main display is changed. The current measured value can be checked in the sub display.

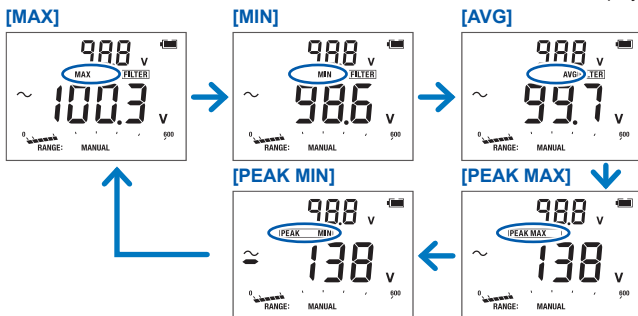

When changing back to the measurement display
 Press for at least 1 second.

Displaying “MAX and MIN” or “PEAK MAX and PEAK MIN” simultaneously

The “maximum value (MAX) and minimum value (MIN)” or the “maximum value of the peak value (PEAK MAX) and minimum value of the peak value (PEAK MIN)” of the measured values can be displayed simultaneously. (Default setting: OFF)

See: “MAX, MIN simultaneous display function enabled/disabled” (p.107)

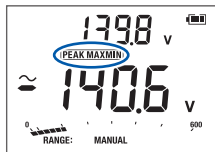
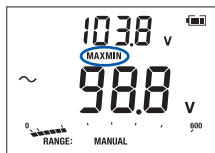

1 Connect the test leads to the object to be measured.

2 Press

The maximum value appears in the sub display and the minimum value appears in the main display.

3 Press

The maximum value of the peak value appears in the sub display and the minimum value of the peak value appears in the main display.

Each time  is pressed, the “MAX and MIN” display and “PEAK MAX and PEAK MIN” display are switched.

When changing back to the measurement display
Press for at least 1 second.

4.5 Zero Adjustment

The effects of wiring resistance can be canceled by performing zero adjustment with the test leads shorted.

Measurement item	Handling the value for which zero adjustment is performed	Count value for which zero adjustment can be performed
Resistance, continuity check	Saved in non-volatile memory.	± 1000 counts* ¹
DC voltage	Deleted when the power is turned off.	± 1000 counts* ¹
AC voltage	Deleted when the power is turned off.	50 counts* ¹
AC current (Clamp sensor)	Deleted when the power is turned off.	5 counts* ²
DC current	Deleted when the power is turned off.	± 1000 counts* ¹
AC current	Deleted when the power is turned off.	50 counts* ¹
Items other than above (Including the peak value)	Zero adjustment is not applicable.	—

*1: Count value for which zero adjustment can be performed in the highest sensitivity range

Zero adjustment can be performed for the input equivalent to the count in the highest sensitivity range for the upper range.

*2: Count value for which zero adjustment can be performed in all ranges

Zero adjustment is not applicable for maximum value of the peak value (PEAK MAX) or minimum value of the peak value (PEAK MIN).



Press the key for at least 1 second.



Zero adjustment screen



Screen displayed when zero adjustment fails

4

Example: Resistance measurement

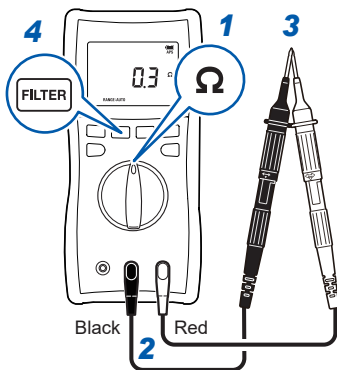

- 1** Select the measurement function.
- 2** Connect the test leads to the measurement terminals.
- 3** Allow the test leads to short-circuit.
- 4** Press **FILTER** for at least 1 second.
(After zero adjustment: 0.0 Ω)
- 5** Measure the resistance.

4.6 Backlight

Display backlight

The lit backlight makes it easier to view the display even in a dark place.

Turns off

(Default setting)

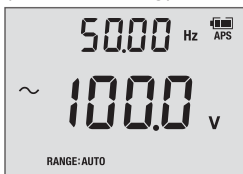

Lights up (white)

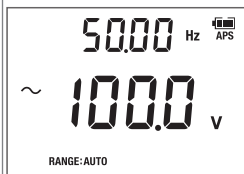

Otherwise, it turns off automatically after 40 seconds if no operation is performed.*

*: The automatic backlight deactivation function can be disabled.
(Default setting: Enabled)

Disabling the automatic backlight deactivation

With the power off, turn the rotary switch while holding down the backlight key. (p. 104)



Warning backlight (Red)

The warning backlight operates only for the current measured value and not for the retained value or recorded value of the MAX, MIN, AVG, PEAK MAX, or PEAK MIN display function.

See: "1.3 Alarm Display and Battery Indicator" (p. 28)

4.7 Auto Power Save (APS)

The auto power save function saves on battery consumption. When the power is turned on, the auto power save function is automatically enabled. If the instrument is to be used continuously for an extended period of time, disable the auto power save function.

Enabled ([APS] lights up) (Default setting)

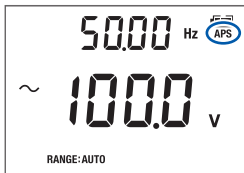

→
No
operation
for approx.
15 minutes

Sleep mode ([APS] blinks 30 seconds before.)



(Continued for
approx. 45 minutes.)

→ **Power OFF**

Turn the rotary switch to OFF after use. A small amount of battery power is used in sleep mode.

Resuming from sleep mode

Press any key, operate the rotary switch, or use the DT4900-01 to communicate with the instrument.

Resuming from a power shutdown

Set the rotary switch to OFF and turn on the power again.

Selecting \sim A or AUTO A with the rotary switch while the test leads are connected to the current measurement terminal (A terminal) will cause the instrument to turn back on.

Disabling the APS function

With the power off, turn the rotary switch while holding down the **HOLD** key.

 +  (Any position) → [APS] goes off

Enabling the APS function again

Turn the power off and then back on again. → [APS] lights up

4.8 DC Voltage Positive/Negative Judgment Function

When the measured DC voltage value is less than or equal to the reference value, a buzzer sounds and the backlight turns on in red. This function can be used to check for any connection errors of the DC power line.

(Default setting: Disabled)

Reference value: -10 V or less

Measurement function: DC V, AUTO V, or LoZ V

Enabling/disabling the DC voltage positive/negative judgment function

With the power off, turn the rotary switch while holding down the **MAX/MIN PEAK** key.



4.9 Communication with the PC

Using the DT4900-01 Communication Package (option), it is possible to transmit data to the PC or to control the instrument.

Installing the special software on the PC

(See the Instruction Manual which accompanies with the communication package.)

Attaching the communication adapter to the instrument (p.94)

Connecting to the computer

The virtual COM ports of the PC are used as the USB interface. The virtual COM ports that can recognize the instrument are COM1 to COM256.

4

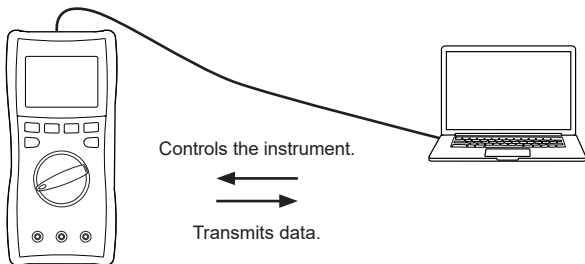

Communication method	Infrared asynchronous serial communication (half-duplex)
Communication content	<ul style="list-style-type: none"> • Response with measurement data • The key operation function can be set on the PC.
Transmission speed	9600 bps
Data length	8 bits
Stop bit	1
Parity bit	No
Delimiter	CR+LF

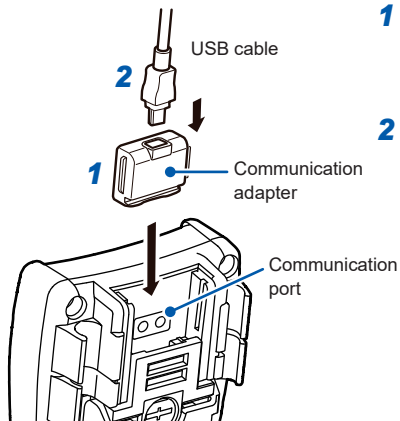

Attaching the communication adapter to the instrument



- 1** Attach the communication adapter to the instrument.
- 2** Connect the USB cable to the communication adapter.

- Connect the cables, being careful to orient each cable correctly.
- During communication, the  symbol appears on the display.
- When the  symbol is lit, the operation keys of the instrument are disabled.
- During communication, do not disconnect the USB cable. Disconnecting the cable stops the communication. In that case, a warning is displayed by the PC software. Connect the cable again.
- It is possible to use the instrument while the communication adapter is attached, however, the communication adapter is excluded from the drop-proof.
- When the wireless communications function is ON, communication using the DT4900-01 cannot be performed.

4.10 Wireless Communications Function

The Z3210 Wireless Adapter (option) is required. GENNECT Cross and the HID function (p.99) cannot be used simultaneously.

Using GENNECT Cross

Using GENNECT Cross allows you to check and record the measured data of the instrument, and create measurement reports using your mobile device. It provides various functionality, including harmonic measurement. For details, see the Help function of the GENNECT Cross (application software, free of charge).

GENNECT Cross special site
<https://gennect.net/en/cross/index>



- The communication distance is approximately 10 m with a clear line of sight. The communication distance may vary greatly depending on the presence of an obstruction (wall or metallic shielding object) and the distance between the floor (ground) and instrument. To ensure the stable communication, make sure that the radio wave intensity is sufficient.
- GENNECT Cross is free of charge. However, the customer is responsible for the cost to download the application software and connect to the Internet when using the software.
- GENNECT Cross may not operate properly depending on the mobile device.
- The Z3210 uses the 2.4 GHz band wireless technology. When there is a device that uses the same frequency band such as a wireless LAN (IEEE 802.11.b/g/n) near your mobile device, the communication may not be established.



When the instrument is placed on the floor or ground, the communication distance becomes shorter. It is recommended that you move the instrument from the floor or ground and place it on a desk or table or hold it by hand.

Using the wireless communications function

- 1 Install the Z3210 Wireless Adapter (option) to the instrument (p.41).
- 2 Install GENNECT Cross on your mobile device.
- 3 Turn on the instrument, and then enable the wireless communications function.

When the power is turned on for the first time after the Z3210 is installed, the wireless communications function is automatically set to ON.

OFF
(Default setting)

Press for at least 1 second.



 **symbol lights up**
(Wireless communications function ON)

Off: Wireless communications function OFF
Blinking: Wireless communications in process

4

- 4 Start GENNECT Cross and connect and register the instrument.

Tap **[Other]**.

Tap **[Instrument Settings]**.

Select the instrument to connect.

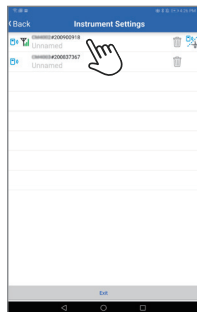
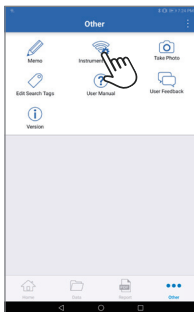

Continued to the next page →

- At the time of initial startup (with no device registered), GENNECT Cross starts up with the Instrument Settings screen.
- When the instrument is nearby, it is automatically connected and registered in the connection setting screen (up to 8 devices).
- Wait for 5 to 30 seconds for the instrument to be connected and registered after turning on the power to the instrument. If the instrument is not registered after 1 minute, restart GENNECT Cross and the instrument.

5 Select a function and perform measurement.

Event recording function (EVENT)

The event recording function logs the data when measured values exceed a desired threshold value, which can be set with GENNECT Cross. For details, see the Help function in GENNECT Cross. The number of recorded events can be checked on the instrument.

Press for at least
1 second.



Number of events
displayed

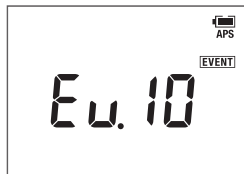

An event with a duration time of less than 200 ms may not be accurately measured, failing to detect the event.

The instrument can record up to 99 events. The event recording will terminate when the recorded events reach 99 in number.

When you start another event recording session, the instrument will delete previously recorded data.

Z3210-to Excel® direct data entry function (Excel® direct input function, HID function)

The HID function and GENNECT Cross cannot be used simultaneously.

Human Interface Device Profile (HID), with which the Z3210 Wireless Adapter is equipped, is a profile same as that wireless keyboard use.

HID ON	Preparatory to data entry, open an Excel® file on your mobile device or computer and choose a cell. When the instrument's display freezes, the measured values will be entered on the cells. The use of this function with the AUIP HOLD function enabled comes in handy. (p.80)
HID OFF	When you wish to use GENNECT Cross, disable the HID function.

4

The setting whether the HID function has been enabled or disabled will not be saved in the instrument but in the Z3210.

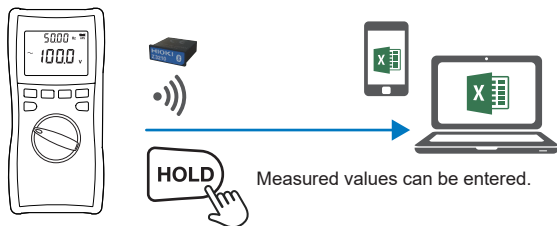

Continued to the next page →

Confirming the HID setting

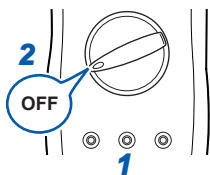

- 1 Remove the test leads from the instrument.
- 2 Set the rotary switch to OFF.

3 Install the Z3210 Wireless Adapter (option) to the instrument.

See: "Z3210 Wireless Adapter installation procedure" (p.42)

4 Check the HID setting.

With the power off, turn the rotary switch while holding down the **RANGE** key.

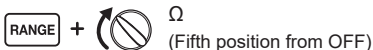

The setting saved in the Z3210 is displayed.

When [----] is displayed

Update the Z3210 to the latest version using GENNECT Cross (version 1.8 or later).



or

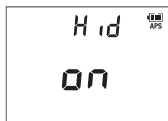

See the procedure on the next page when changing the HID setting.

Changing the HID setting

- 1 Turn off the power.
- 2 Turn on the power as follows.

 +  +  (Any position)

After displaying the following screens in turn, the instrument will be turned off automatically.

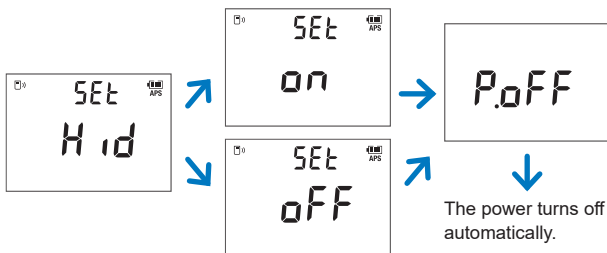

4

- 3 Turn on the power again.
The HID setting is changed.

Continued to the next page →

IMPORTANT

To switch over from the HID function to GENNECT Cross

If you start GENNECT Cross without canceling the pairing between the mobile device and the instrument, GENNECT Cross may not be able to recognize the instrument as a connectible device. Follow the procedure below to reconnect the instrument to GENNECT Cross.

1. Use the **Bluetooth**[®] setting of your mobile device to delete the instrument.
2. Disable the Z3210's HID function. (p. 101)
3. Use the Instrument Settings of GENNECT Cross to reconnect the instrument.

For details, please visit the Z3210's website.

<https://z3210.gennect.net>









▲
Learn more here!









4.11 Power-On Option Table





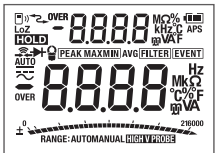

The settings in the instrument can be changed or checked. The display will change to the measurement screen when the operation key is released.

+  **Turn off the power and then turn back on the power while pressing the operation key.**











(Turn the rotary switch from OFF.)

Description	Procedure/Display	Setting saved
Disabling the auto power save function (APS) (See: p.91)	With power off  +  (Any position)  ([APS] off)	No
Buzzer sound ON/OFF	With power off  +  (Any position) 	Yes

Description	Procedure/Display	Setting saved
<p>Automatic display backlight deactivation function enabled/disabled</p> <p>(See: p.90)</p>	<p>With power off</p> <p> +  (Any position)</p> 	Yes
<p>DC voltage positive/negative judgment function enabled/disabled</p> <p>(See: p.92)</p>	<p>With power off</p> <p> +  (Any position)</p> 	Yes
<p>Displaying all LCD segments</p> <p>(See: p.53)</p>	<p>With power off</p> <p> +  AUTO V (First position from OFF)</p> <p>If any of the display segments are missing, request repair.</p> 	-

Description	Procedure/Display	Setting saved
Software version display	<p>With power off</p> <p> +  ~V (Second position from OFF)</p> <p>Example: Ver 1.00</p> 	-
Model number display	<p>With power off</p> <p> +  LoZ V (Third position from OFF)</p> 	-

Description	Procedure/Display	Setting saved
<p data-bbox="101 256 269 314">Serial number display</p> <div data-bbox="107 372 306 515"> </div> <p data-bbox="190 518 232 570">↓</p> <div data-bbox="107 576 306 716"> </div> <p data-bbox="308 634 356 672">→</p> <div data-bbox="360 576 557 716"> </div> <p data-bbox="559 634 607 672">→</p> <div data-bbox="611 576 808 716"> </div> <p data-bbox="180 719 710 765">↑</p>	<p data-bbox="341 209 503 238">With power off</p> <div data-bbox="346 253 542 311"> </div> <p data-bbox="557 253 787 349"> (Fourth position from OFF) </p> <p data-bbox="358 401 793 556"> While the key is being pressed, the display changes in the following order. The manufacturing month and year shown in the following figure are August and 2021, respectively. </p>	-
<p data-bbox="101 859 310 955">HID setting check (Only when Z3210 is installed)</p> <p data-bbox="101 998 240 1027">(See: p. 100)</p>	<p data-bbox="341 783 503 812">With power off</p> <div data-bbox="346 827 542 885"> </div> <p data-bbox="557 827 764 923"> (Fifth position from OFF) </p> <div data-bbox="341 928 580 1097"> </div>	-

Description	Procedure/Display	Setting saved
User setting retention function enabled/disabled	<p>With power off</p> <p> +  (Any position)</p> <div data-bbox="346 331 582 497" style="border: 1px solid black; padding: 5px; text-align: center;">  </div> <p>The most recently used values for the following settings are recorded for each rotary switch position.</p> <ul style="list-style-type: none"> • Measurement items • Range setting • Filter setting 	Yes
MAX, MIN simultaneous display function enabled/disabled (See: p.87)	<p>With power off</p> <p> +  +  (Any position)</p> <div data-bbox="346 827 582 992" style="border: 1px solid black; padding: 5px; text-align: center;">  </div>	Yes
ON/OFF of the HID function (Only when the Z3210 is installed) (See: p.101)	<p>With power off</p> <p> +  +  (Any position)</p>	—*

*: The ON/OFF setting of HID is saved in the Z3210.

5

Specifications

5.1 General Specifications

Operating environment Indoors, pollution degree 2, altitude up to 2000 m (6562 ft.)

Operating temperature and humidity range Temperature
 -25°C to 65°C (-13.0°F to 149.0°F)
 Humidity
 -25°C to 40°C (-13.0°F to 104.0°F): 80% RH or less (non-condensing)
 40°C to 65°C (104.0°F to 149.0°F): Linearly reduces from 80% RH or less at 40°C (104.0°F) to 25% RH or less at 65°C (149.0°F) (non-condensing).

Temperature derating

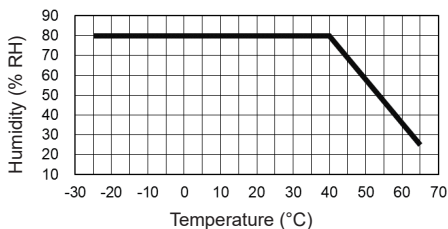

Storage temperature and humidity range -30°C to 70°C (-22.0°F to 158.0°F), 80% RH or less (non-condensing)

Dust resistance and water resistance

IP50 (when in use), IP54 (storage)

Do not use the instrument when it is wet. Terminals are excluded. (EN 60529)

The protection ratings for the enclosure of this instrument (based on EN60529) are IP50* (when in use) and IP54* (storage).

*IP50, IP54:

This indicates the degree of protection provided by the enclosure of the device for use in hazardous locations, entry of solid foreign objects, and the ingress of water.

“5”: Protected against access to hazardous parts with wire measuring 1.0 mm in diameter. Dustproof type (The penetration of dust cannot be prevented completely, but quantities of dust that may hinder the stated operation of equipment or safety cannot penetrate the enclosure.)

“0”: The equipment inside the enclosure is not protected against the harmful effects of water.

“4”: The equipment inside the enclosure is protected against the harmful effects of water splashed against the enclosure from any direction.



Drop-proof functionality	1 m on concrete
Standards	Safety EN 61010 EMC EN 61326
Power supply	LR6 Alkaline battery ×3 Rated supply voltage: 1.5 V DC × 3 Maximum rated power: 800 mVA Rated power: 50 mVA + 20% or less (Power voltage: 4.5 V, AUTO V, backlight off) 15 mVA + 20% or less (Power voltage 4.5 V, sleep mode)

Continuous operating time	LR6 Alkaline battery ×3 used (Reference value with AUTO V, backlight off, 23°C) Approx. 130 hours (Without Z3210) Approx. 70 hours (With Z3210 and during wireless communications)
Interfaces	Connector for DT4900-01 (USB communication can be performed with the DT4900-01 installed.) Connector for Z3210 (Wireless communications can be performed with the Z3210 installed.)
Dimensions	Approx. 87W × 185H × 47D mm (3.43" W × 7.28" H × 1.85" D)
Weight	Approx. 480 g (16.9 oz.) (With batteries)
Product warranty duration	3 years
Fuse	For current terminal 11 A/1000 V Breaking capacity: 50 kA AC/30 kA DC, fast-blow type Diam. 10.3 × 38 mm Manufacturer: Hollyland The fuse can be changed by the user.
Accessories	See: p.2
Options	See: p.2

5.2 Input and Measurement Specifications

Basic specifications

Measurement specifications

Measurable range	See: "Accuracy table" (p. 115)	
Maximum input voltage (Maximum rated voltage between terminals)	V terminal 1000 V DC/1000 V AC	
Maximum input current (Maximum rated current between terminals)	A terminal 10 A DC/10 A AC	
Maximum rated line-to-ground voltage	1000 V (Measurement category III) 600 V (Measurement category IV) Anticipated transient overvoltage: 8000 V	
Measurement method	True RMS	
Measurement terminals	Voltage terminal	(V Ω  \rightarrow \leftarrow \leftarrow \leftarrow )
	COM terminal	(COM)
	Current terminal	(A)
Noise rejection characteristics NMRR	DC V measurement: -60 dB or more (50 Hz/60 Hz)	
Noise rejection characteristics CMRR	DC V measurement: -100 dB or more (DC/50 Hz/60 Hz, 1 k Ω unbalance) AC V measurement: -60 dB or more (DC/50 Hz/60 Hz, 1 k Ω unbalance)	

Response time Time from when the power is turned on until the value is displayed (open terminal)

- AC voltage, resistance: 2 seconds or less

Time until the displayed value falls within the accuracy specification range

- AUTO V: 1.2 seconds or less
(Open terminal → 100 V, 50 Hz, auto range)
- DC voltage: 0.8 seconds or less
(Open terminal → 100 V DC, auto range)
- AC voltage: 0.7 seconds or less
(Open terminal → 100 V, 50 Hz, auto range)
- Resistance: 1.1 seconds or less
(Open terminal → Terminal short circuit, auto range)

Display update rate*

- Measured value: 5 times/second (excluding electrostatic capacity and frequency after the range is fixed)
0.05 to 5 times/second (When measuring electrostatic capacitance, varies with the electrostatic capacitance value.)
1 to 2 times/second (frequency)
- Bar graph: 25 times/second

* The range movement time is not included.

Peak value detection time width 1 ms or more

Accuracy specifications

Accuracy guarantee conditions	<p>Accuracy guarantee duration: 1 year</p> <p>Accuracy guarantee duration after adjustment made by Hioki: 1 year</p> <p>Accuracy guarantee temperature and humidity range: 23°C ±5°C (73.0°F ± 9.0°F), 80% RH or less (Non-condensation)</p> <p>Accuracy guarantee supply voltage range: 3.0 V ±0.1 V or more (Until the power is off)</p> <p>Other: When the L4931 Extension Cable Set is connected, the accuracy is guaranteed with the cable length 3 m or less.</p>
Measurement accuracy	<p>See: "Accuracy table" (p. 115)</p> <p>The AC waveform must be a sine wave.</p>
Temperature coefficient	<p>Outside the 23°C ±5°C range, (Measurement accuracy × 0.1)/°C is added to the measurement accuracy.</p>

Accuracy table

The AC waveform must be a sine wave.

1. AUTO V (AC voltage/DC voltage automatic judgment)

AC judgment: The same as the accuracy specifications in "3. AC + DC voltage" (p. 116)

DC judgment: The same as the accuracy specifications in "2. DC voltage" (p. 115)

2. DC voltage

Measured value (Measured value/MAX/MIN/AVG)

Range	Display range (Accuracy guarantee range)	Accuracy* ¹	Input impedance
600.0 mV	-600.0 mV to 600.0 mV	±0.15% rdg ±5 dgt	11.3 MΩ ±2.0%
6.000 V	-6.000 V to 6.000 V	±0.15% rdg ±2 dgt	11.3 MΩ ±2.0%
60.00 V	-60.00 V to 60.00 V	±0.15% rdg ±2 dgt	10.4 MΩ ±2.0%
600.0 V	-600.0 V to 600.0 V	±0.15% rdg ±2 dgt	10.3 MΩ ±1.5%
1000 V	-1000 V to 1000 V	±0.15% rdg ±5 dgt	10.3 MΩ ±1.5%

Overload protection: 1100 V DC/1100 V AC or 2×10^7 V · Hz, whichever is lower (Applied for 1 minute)

Coupling type: DC coupling

Auto range movement threshold: More than 6000 counts for upper range
Less than 540 counts for lower range

*1: ±1 dgt should be added to 5% or less of the range.

Peak value (PEAK MAX/PEAK MIN)

Range	Display range (Accuracy guarantee range)	Accuracy
60.00 V	-120.0 V to 120.0 V	±1.0% rdg ±7 dgt
600.0 V	-1000 V to 1000 V	±1.0% rdg ±7 dgt
1000 V	-1000 V to 1000 V	±1.0% rdg ±7 dgt

Input impedance, overload protection, coupling type: The same as the DC voltage measured value

Range movement: Based on the range movement of the DC voltage measured value

3. AC + DC voltage

RMS value (Measured value/MAX/MIN/AVG)

Range	Display range (Accuracy guarantee range)	Accuracy*1		Input impedance
		DC, 40 Hz ≤ f ≤ 500 Hz	500 Hz < f ≤ 1 kHz	
6.000 V	0.000 V to 6.000 V (0.060 V to 6.000 V)	±1.0% rdg ±13 dgt	±1.5% rdg ±13 dgt	11.3 MΩ ±2.0% 100 pF or less
60.00 V	0.00 V to 60.00 V (0.60 V to 60.00 V)	±1.0% rdg ±13 dgt	±1.5% rdg ±13 dgt	10.4 MΩ ±2.0% 100 pF or less
600.0 V	0.0 V to 600.0 V (6.0 V to 600.0 V)	±1.0% rdg ±13 dgt	±1.5% rdg ±13 dgt	10.3 MΩ ±1.5% 100 pF or less
1000 V	0 V to 1000 V (10 V to 1000 V)	±1.0% rdg ±13 dgt	±1.5% rdg ±13 dgt	10.3 MΩ ±1.5% 100 pF or less

Overload protection: 1100 V DC/1100 V AC or 2×10^7 V · Hz, whichever is lower
(Applied for 1 minute)
Transient overvoltage 8000 V

Crest factor: 3 up to 4000 counts
Reduces linearly to 2 at 6000 counts.
2 up to 750 counts and reduces linearly to 1.5 at 1000 counts only in the 1000 V range.

Coupling type: DC coupling

Auto range movement threshold: More than 6000 counts for upper range
Less than 540 counts for lower range

*1: ±5 dgt should be added to 5% or less of the range.
When the filter is ON
100 Hz: ±1.5% rdg added in the range of 40 Hz to 100 Hz,
no specified accuracy over 100 Hz
500 Hz: ±0.5% rdg added in the range of 40 Hz to 500 Hz,
no specified accuracy over 500 Hz

Peak value (PEAK MAX/PEAK MIN)

Range	Display range (Accuracy guarantee range)	Accuracy	
		DC, 40 Hz ≤ f ≤ 500 Hz	500 Hz < f < 1 kHz
60.00 V	-120.0 V to 120.0 V (±3.0 V to ±120.0 V)	±1.0% rdg ±7 dgt	±1.5% rdg ±7 dgt
600.0 V	-1200 V to 1200 V (±30 V to ±1000 V)	±1.0% rdg ±7 dgt	±1.5% rdg ±7 dgt
1000 V	-1500 V to 1500 V (±50 V to ±1000 V)	±1.0% rdg ±7 dgt	±1.5% rdg ±7 dgt

Input impedance, overload protection, coupling type:
The same as the AC + DC voltage RMS value (p. 116)

Range movement: Based on the range movement of the AC + DC voltage RMS value

4. AC voltage

RMS value (Measured value/MAX/MIN/AVG)

Range	Display range (Accuracy guarantee range)	Accuracy* ¹		Input impedance
		40 Hz ≤ f ≤ 500 Hz	500 Hz < f ≤ 1 kHz	
6.000 V	0.000 V to 6.000 V (0.060 V to 6.000 V)	±0.9% rdg ±3 dgt	±1.5% rdg ±3 dgt	11.3 MΩ ±2.0% 100 pF or less
60.00 V	0.00 V to 60.00 V (0.60 V to 60.00 V)	±0.9% rdg ±3 dgt	±1.5% rdg ±3 dgt	10.4 MΩ ±2.0% 100 pF or less
600.0 V	0.0 V to 600.0 V (6.0 V to 600.0 V)	±0.9% rdg ±3 dgt	±1.5% rdg ±3 dgt	10.3 MΩ ±1.5% 100 pF or less
1000 V	0 V to 1000 V (10 V to 1000 V)	±0.9% rdg ±3 dgt	±1.5% rdg ±3 dgt	10.3 MΩ ±1.5% 100 pF or less

Overload protection: 1100 V DC/1100 V AC or 2×10^7 V · Hz, whichever is lower
(Applied for 1 minute)
Transient overvoltage 8000 V

Crest factor: 3 up to 4000 counts
Reduces linearly to 2 at 6000 counts.
2 up to 750 counts and reduces linearly to 1.5 at 1000 counts only in the 1000 V range.

Coupling type: AC coupling

Auto range movement threshold: More than 6000 counts for upper range
Less than 540 counts for lower range

*1: ±5 dgt should be added to 5% or less of the range.

When the filter is ON

100 Hz: ±1.5% rdg added in the range of 40 Hz to 100 Hz,
no specified accuracy over 100 Hz

500 Hz: ±0.5% rdg added in the range of 40 Hz to 500 Hz,
no specified accuracy over 500 Hz

Peak value (PEAK MAX/PEAK MIN)

Range	Display range (Accuracy guarantee range)	Accuracy	
		$40 \text{ Hz} \leq f \leq 500 \text{ Hz}$	$500 \text{ Hz} < f < 1 \text{ kHz}$
60.00 V	-120.0 V to 120.0 V ($\pm 3.0 \text{ V}$ to $\pm 120.0 \text{ V}$)	$\pm 1.0\% \text{ rdg} \pm 7 \text{ dgt}$	$\pm 1.5\% \text{ rdg} \pm 7 \text{ dgt}$
600.0 V	-1200 V to 1200 V ($\pm 30 \text{ V}$ to $\pm 1000 \text{ V}$)	$\pm 1.0\% \text{ rdg} \pm 7 \text{ dgt}$	$\pm 1.5\% \text{ rdg} \pm 7 \text{ dgt}$
1000 V	-1500 V to 1500 V ($\pm 50 \text{ V}$ to $\pm 1000 \text{ V}$)	$\pm 1.0\% \text{ rdg} \pm 7 \text{ dgt}$	$\pm 1.5\% \text{ rdg} \pm 7 \text{ dgt}$

Input impedance, overload protection, coupling type:
The same as the AC voltage RMS value (p. 118)
Range movement: Based on the range movement of the AC voltage RMS value

5. Voltage frequency

Range	Display range (Accuracy guarantee range)	Accuracy* ²	Minimum sensitivity voltage			
			6.000 V range	60.00 V range	600.0 V range	1000 V range
99.99 Hz	5.00 Hz to 99.99 Hz (5.00 Hz to 99.99 Hz* ¹)	±0.1% rdg ±1 dgt	0.600 V	6.00 V	60.0 V	100 V
999.9 Hz	40.0 Hz to 999.9 Hz (40.0 Hz to 999.9 Hz)	±0.1% rdg ±1 dgt	0.600 V	6.00 V	60.0 V	100 V
9.999 kHz	0.100 kHz to 9.999 kHz (0.100 kHz to 9.999 kHz)	±0.1% rdg ±1 dgt	0.600 V	6.00 V	60.0 V	100 V
99.99 kHz	1.00 kHz to 50.00 kHz (1.00 kHz to 50.00 kHz)	±0.1% rdg ±1 dgt	1.800 V	12.00 V	120.0 V	230 V
	Over 50.00 kHz to 99.99 kHz (Over 50.00 kHz to 99.99 kHz)	±0.1% rdg ±1 dgt	3.000 V	24.00 V	240.0 V	400 V

Input impedance, overload protection, coupling type: The same as the AC voltage RMS value (p. 118)

Auto range movement threshold: More than 9999 counts for upper range
Less than 900 counts for lower range

If the voltage frequency is displayed in the main display, the AC voltage range is fixed to the 6.000 V range.

If the voltage frequency is displayed in the sub display, the voltage frequency range is fixed to the auto range mode.

*1: The measurement range of 5.00 Hz and above is only for the 6.000 V range.

The measurement range for other voltage ranges is 40.00 Hz to 99.99 Hz.

*2: ±2 dgt should be added to 20% or less of the range.

6. LoZ V (Low input impedance voltage measurement)

Range	Display range (Accuracy guarantee range)	Accuracy* ¹		Input impedance
		DC, 40 Hz ≤ f ≤ 500 Hz	500 Hz < f ≤ 1 kHz	
600.0 V	AC judgment: 0.0 V to 600.0 V (6.0 V to 600.0 V) DC judgment: -600.0 V to 600.0 V	±1.0% rdg ±13 dgt	±1.5% rdg ±13 dgt	1.0 MΩ ±20%
Overload protection: 1100 V DC/1100 V AC or 2×10^7 V · Hz, whichever is lower (Applied for 1 minute) Transient overvoltage 8000 V Crest factor: 3 up to 4000 counts Reduces linearly to 2 at 6000 counts. Coupling type: DC coupling *1: ±5 dgt should be added to 5% or less of the range. When the filter is ON 100 Hz: ±1.5% rdg added in the range of 40 Hz to 100 Hz, no specified accuracy over 100 Hz 500 Hz: ±0.5% rdg added in the range of 40 Hz to 500 Hz, no specified accuracy over 500 Hz				

7. Continuity

Range	Accuracy	Measurement current	Open circuit voltage
600.0 Ω	±0.7% rdg ±5 dgt	200 μA ±20%	2.0 V DC or less
Overload protection: 1000 V DC/1000 V AC or 2×10^7 V · Hz (Applied for 1 minute) Current under overload Steady state: 15 mA or less Transient state: 1.6 A or less Continuity ON threshold value: 25 Ω ±10 Ω (continuous buzzer sound, red backlight turns on) Continuity OFF threshold value: 245 Ω ±10 Ω Response time: Open circuit or short circuit is detected for at least 0.5 ms. Accuracy guarantee conditions: After zero adjustment			

8. Diode test

Range	Accuracy	Measurement current	Open circuit voltage
1.800 V	$\pm 0.5\%$ rdg ± 5 dgt	200 μ A $\pm 20\%$	2.0 V DC or less
Overload protection: 1000 V DC/1000 V AC or 2×10^7 V · Hz, whichever is lower (Applied for 1 minute) Current under short circuit: 200 μ A $\pm 20\%$ Current under overload Steady state: 15 mA or less Transient state: 1.6 A or less During the forward connection, an intermittent buzzer sounds (Threshold: 0.15 V to 1.8 V) When less than 0.15 V, continuous buzzer sound, red backlight turns on			

9. Resistance

Range	Accuracy	Measurement current	Open circuit voltage
600.0 Ω	$\pm 0.7\%$ rdg ± 5 dgt	200 μ A $\pm 20\%$	2.0 V DC or less
6.000 k Ω	$\pm 0.7\%$ rdg ± 3 dgt	100 μ A $\pm 20\%$	2.0 V DC or less
60.00 k Ω	$\pm 0.7\%$ rdg ± 3 dgt	10 μ A $\pm 20\%$	2.0 V DC or less
600.0 k Ω	$\pm 0.7\%$ rdg ± 3 dgt	1 μ A $\pm 20\%$	2.0 V DC or less
6.000 M Ω	$\pm 0.9\%$ rdg ± 3 dgt	100 nA $\pm 20\%$	2.0 V DC or less
60.00 M Ω	$\pm 1.5\%$ rdg ± 3 dgt	10 nA $\pm 20\%$	2.0 V DC or less
Overload protection: 1000 V DC/1000 V AC or 2×10^7 V · Hz, whichever is lower (Applied for 1 minute) Current under short circuit: 300 μ A or less Current under overload Steady state: 15 mA or less Transient state: 1.6 A or less Accuracy guarantee conditions: After zero adjustment Auto range movement threshold value: More than 6000 counts for upper range Less than 540 counts for lower range			

10. Electrostatic capacity

Range	Accuracy	Measurement current	Open circuit voltage
1.000 μF	$\pm 1.9\%$ rdg ± 5 dgt	10 nA/100 nA/1 μA $\pm 20\%$	2.0 V DC or less
10.00 μF	$\pm 1.9\%$ rdg ± 5 dgt	100 nA/1 μA /10 μA $\pm 20\%$	2.0 V DC or less
100.0 μF	$\pm 1.9\%$ rdg ± 5 dgt	1 μA /10 μA /100 μA $\pm 20\%$	2.0 V DC or less
1.000 mF	$\pm 1.9\%$ rdg ± 5 dgt	10 μA /100 μA /200 μA $\pm 20\%$	2.0 V DC or less
10.00 mF	$\pm 5.0\%$ rdg ± 20 dgt	100 μA /200 μA $\pm 20\%$	2.0 V DC or less

Overload protection: 1000 V DC/1000 V AC or 2×10^7 V · Hz, whichever is lower
 (Applied for 1 minute)
 Current under short circuit: 300 μA or less
 Current under overload
 Steady state: 15 mA or less
 Transient state: 1.6 A or less

Maximum count for each range: 1100 (1000 for 10.00 mF range)
 Auto range movement threshold value: More than 1100 counts for upper range
 Less than 100 counts for lower range

11. AC current (clamp sensor)

RMS value (Measured value/MAX/MIN/AVG)

Range	Display range (Accuracy guarantee range)	Accuracy (only the instrument)*1		Conversion rate
		40 Hz ≤ f ≤ 500 Hz	500 Hz < f ≤ 1 kHz	
10.00 A	0.00 A to 10.00 A (0.10 A to 10.00 A)	±0.9% rdg ±3 dgt	±1.5% rdg ±3 dgt	0.05 A/mV
20.00 A	0.00 A to 20.00 A (0.20 A to 20.00 A)	±0.9% rdg ±3 dgt	±1.5% rdg ±3 dgt	0.10 A/mV
50.0 A	0.0 A to 50.0 A (0.5 A to 50.0 A)	±0.9% rdg ±3 dgt	±1.5% rdg ±3 dgt	0.25 A/mV
100.0 A	0.0 A to 100.0 A (1.0 A to 100.0 A)	±0.9% rdg ±3 dgt	±1.5% rdg ±3 dgt	0.5 A/mV
200.0 A	0.0 A to 200.0 A (2.0 A to 200.0 A)	±0.9% rdg ±3 dgt	±1.5% rdg ±3 dgt	1.0 A/mV
500 A	0 A to 500 A (5 A to 500 A)	±0.9% rdg ±3 dgt	±1.5% rdg ±3 dgt	2.5 A/mV
1000 A	0 A to 1000 A (10 A to 1000 A)	±0.9% rdg ±3 dgt	±1.5% rdg ±3 dgt	5 A/mV

Use the 9010-50, 9018-50, or 9132-50 Clamp on Probe.

Input impedance: 1.0 MΩ ±20.0%

The accuracy does not include the error of the Clamp on Probe.

The maximum input is based on the Clamp on Probe specifications.

Manual range only

Overload protection: 1000 V DC/1000 V AC or 2×10^7 V · Hz, whichever is lower
(Applied for 1 minute)

Crest factor: 3 or less

Coupling type: DC coupling

*1: ±5 dgt should be added to 5% or less of the range.

When the filter is ON

100 Hz: ±1.5% rdg added in the range of 40 Hz to 100 Hz,
no specified accuracy over 100 Hz

500 Hz: ±0.5% rdg added in the range of 40 Hz to 500 Hz,
no specified accuracy over 500 Hz

Peak value (PEAK MAX/PEAK MIN)

Range	Display range (Accuracy guarantee range)	Accuracy (only the instrument)	
		40 Hz ≤ f ≤ 500 Hz	500 Hz < f < 1 kHz
10.00 A	-30.0 A to 30.0 A (±2.0 A to ±30.0 A)	±1.5% rdg ±7 dgt	±2.0% rdg ±7 dgt
20.00 A	-60.0 A to 60.0 A (±4.0 A to ±60.0 A)	±1.5% rdg ±7 dgt	±2.0% rdg ±7 dgt
50.0 A	-150 A to 150 A (±10 A to ±150 A)	±1.5% rdg ±7 dgt	±2.0% rdg ±7 dgt
100.0 A	-300 A to 300 A (±20 A to ±300 A)	±1.5% rdg ±7 dgt	±2.0% rdg ±7 dgt
200.0 A	-600 A to 600 A (±40 A to ±600 A)	±1.5% rdg ±7 dgt	±2.0% rdg ±7 dgt
500 A* ¹	-1500 A to 1500 A (±100 A to ±1500 A)	±1.5% rdg ±70 dgt	±2.0% rdg ±70 dgt
1000 A* ¹	-1500 A to 1500 A (±200 A to ±1500 A)	±1.5% rdg ±70 dgt	±2.0% rdg ±70 dgt

Input impedance, conversion rate, coupling type:
 The same as the AC current (clamp sensor) RMS value (p. 124)
 The accuracy does not include the error of the Clamp on Probe.
 The maximum input is based on the Clamp on Probe specifications.
 *1: Minimum resolution 10 A

12. AC current

RMS value (Measured value/MAX/MIN/AVG)

Range	Display range (Accuracy guarantee range)	Accuracy*1		Input impedance
		40 Hz ≤ f ≤ 500 Hz	500 Hz < f ≤ 1 kHz	
600.0 mA	0.0 mA to 600.0 mA (6.0 mA to 600.0 mA)	±1.4% rdg ±3 dgt	±1.8% rdg ±3 dgt	35 mΩ ±30%
6.000 A	0.000 A to 6.000 A (0.060 A to 6.000 A)	±1.4% rdg ±3 dgt	±1.8% rdg ±3 dgt	
10.00 A	0.00 A to 10.00 A (0.10 A to 10.00 A)	±1.4% rdg ±3 dgt	±1.8% rdg ±3 dgt	

Crest factor: 3 up to 4000 counts

Reduces linearly to 2 at 6000 counts (other than 10.00 A range).
1.5 or less (10.00 A range)

Coupling type: DC coupling (The AC component's RMS value calculated by the software is displayed.

The bar graph, however, displays RMS value for the AC + DC component.)

Auto range movement threshold: More than 6000 counts for upper range
Less than 540 counts for lower range

*1: ±5 dgt should be added to 5% or less of the range.

When the filter is ON

100 Hz: ±1.5% rdg added in the range of 40 Hz to 100 Hz,
no specified accuracy over 100 Hz

500 Hz: ±0.5% rdg added in the range of 40 Hz to 500 Hz,
no specified accuracy over 500 Hz

Peak value (PEAK MAX/PEAK MIN)

Range	Display range (Accuracy guarantee range)	Accuracy		Input impedance
		40 Hz ≤ f ≤ 500 Hz	500 Hz < f < 1 kHz	
600.0 mA	-1200 mA to 1200 mA (±30 mA to ±1200 mA)	±1.5% rdg ±7 dgt	±2.0% rdg ±7 dgt	35 mΩ ±30%
6.000 A	-12.00 A to 12.00 A (±0.30 A to ±10.00 A)	±1.5% rdg ±7 dgt	±2.0% rdg ±7 dgt	
10.00 A	-15.00 A to 15.00 A (±0.50 A to ±10.00 A)	±1.5% rdg ±7 dgt	±2.0% rdg ±7 dgt	

Coupling type: DC coupling (Only the peak value for the AC component is calculated by the software.)
Range movement: Based on the range movement of the AC current RMS value (p. 126)

13. Current frequency

Range	Display range (Accuracy guarantee range)	Accuracy* ¹	Minimum sensitivity current		
			600.0 mA Range	6.000 A Range	10.00 A Range
99.99 Hz	40.00 Hz to 99.99 Hz (40.00 Hz to 99.99 Hz)	±0.1% rdg ±1 dgt	60.0 mA	0.600 A	3.00 A
999.9 Hz	40.0 Hz to 999.9 Hz (40.0 Hz to 999.9 Hz)	±0.1% rdg ±1 dgt			
9.999 kHz	0.100 kHz to 9.999 kHz (0.100 kHz to 9.999 kHz)	±0.1% rdg ±1 dgt			

Input impedance, coupling type: The same as the AC current RMS value (p. 126)
Auto range movement threshold: More than 9999 counts for upper range
Less than 900 counts for lower range
If the current frequency is displayed in the main display, the AC current range is fixed to the 600.0 mA range.
If the current frequency is displayed in the sub display, the current frequency range is fixed to the auto range mode.
*1: ±2 dgt should be added to 20% or less of the range.

Input and Measurement Specifications

14. AUTO A (AC current/DC current automatic judgment)

AC judgment: The same as the accuracy specifications in "16. AC + DC current" (p. 129)

DC judgment: The same as the accuracy specifications in "15. DC current" (p. 128)

15. DC current

Measured value (Measured value/MAX/MIN/AVG)

Range	Display range (Accuracy guarantee range)	Accuracy* ¹	Input impedance
600.0 mA	-600.0 mA to 600.0 mA	±0.5% rdg ±3 dgt	35 mΩ ±30%
6.000 A	-6.000 A to 6.000 A	±0.5% rdg ±3 dgt	
10.00 A	-10.00 A to 10.00 A	±0.5% rdg ±3 dgt	
Coupling type: DC coupling Auto range movement threshold: More than 6000 counts for upper range Less than 540 counts for lower range *1: ±2 dgt should be added to 5% or less of the range.			

Peak value (PEAK MAX/PEAK MIN)

Range	Display range (Accuracy guarantee range)	Accuracy	Input impedance
600.0 mA	-1200 mA to 1200 mA	±1.5% rdg ±7 dgt	35 mΩ ±30%
6.000 A	-10.00 A to 10.00 A	±1.5% rdg ±7 dgt	
10.00 A	-10.00 A to 10.00 A	±1.5% rdg ±7 dgt	
Coupling type: The same as the DC current measured value Range movement: Based on the range movement of the DC current measured value			

16. AC + DC current

RMS value (Measured value/MAX/MIN/AVG)

Range	Display range (Accuracy guarantee range)	Accuracy*1		Input impedance
		DC, 40 Hz ≤ f ≤ 500 Hz	500 Hz < f ≤ 1 kHz	
600.0 mA	0.0 mA to 600.0 mA (6.0 mA to 600.0 mA)	±1.4% rdg ±3 dgt	±1.8% rdg ±3 dgt	35 mΩ ±30%
6.000 A	0.000 A to 6.000 A (0.060 A to 6.000 A)	±1.4% rdg ±3 dgt	±1.8% rdg ±3 dgt	
10.00 A	0.00 A to 10.00 A (0.10 A to 10.00 A)	±1.4% rdg ±3 dgt	±1.8% rdg ±3 dgt	

Crest factor: 3 up to 4000 counts
Reduces linearly to 2 at 6000 counts (other than 10.00 A range).
1.5 or less (10.00 A range)

Coupling type: DC coupling
Auto range movement threshold: More than 6000 counts for upper range
Less than 540 counts for lower range

*1: ±5 dgt should be added to 5% or less of the range.
When the filter is ON
100 Hz: ±1.5% rdg added in the range of 40 Hz to 100 Hz,
no specified accuracy over 100 Hz
500 Hz: ±0.5% rdg added in the range of 40 Hz to 500 Hz,
no specified accuracy over 500 Hz

Peak value (PEAK MAX/PEAK MIN)

Range	Display range (Accuracy guarantee range)	Accuracy	
		DC, 40 Hz ≤ f ≤ 500 Hz	500 Hz < f < 1 kHz
600.0 mA	-1200 mA to 1200 mA (±30 mA to ±1200 mA)	±1.5% rdg ±7 dgt	±2.0% rdg ±7 dgt
6.000 A	-12.00 A to 12.00 A (±0.30 A to ±10.00 A)	±1.5% rdg ±7 dgt	±2.0% rdg ±7 dgt
10.00 A	-15.00 A to 15.00 A (±0.50 A to ±10.00 A)	±1.5% rdg ±7 dgt	±2.0% rdg ±7 dgt

Input impedance, coupling type: The same as the AC + DC current RMS value
Range movement: Based on the range movement of the AC + DC current RMS value

17. DC high voltage (DC High V Probe mode)

Measured value (Measured value/MAX/MIN/AVG)

Range	Display range (Accuracy guarantee range)	Accuracy in combination with the P2000	Input impedance in combination with the P2000
600.0 V	-600.0 V to 600.0 V (±80.0 V to ±600.0 V)	±0.5% rdg ±0.2 V	20 MΩ ±5.0 %
2000 V	-2000 V to 2000 V (±80 V to ±2000 V)	±0.5% rdg ±5 V	20 MΩ ±5.0 %

Coupling type: DC coupling
Auto range movement threshold: More than 6000 counts for upper range
Less than 540 counts for lower range

Maximum input voltage, maximum rated line-to-ground voltage, overload protection: Based on the P2000 specifications (only in combination with the P2000)

5.3 Other Specifications

Interface specifications

Connector for DT4900-01 Communication Package (USB)



After the instrument receives the command from the PC, the  symbol lights up and communication begins.

After the instrument receives the command from the PC, a response operation is performed.

Communication method	Infrared asynchronous serial communication (half-duplex)
Communication contents	<ul style="list-style-type: none"> • Response with measurement data • The key operation function can be set on the PC.

Connector for Z3210 Wireless Adapter

Set the wireless communications function to ON (pressing  for 1 second or more switches the ON/OFF setting) and start communication.

- Wireless communications function OFF: LCD  symbol off
- Wireless communications function ON: LCD  symbol lights up
- Wireless communications in process: LCD  symbol blinks

When the power is turned on after the Z3210 is installed, the wireless communications function is automatically set to ON.

Communication distance	10 m (line of sight distance)
HID function	Switch the ON/OFF setting of the HID function of the Z3210 in the power-on option. When the HID function is ON, communication with GENNECT Cross cannot be performed.
Upgrade function	Using GENNECT Cross, update the instrument firmware version. Compatible instrument firmware: Version 1.00 or later GENNECT Cross: Version 1.8 or later

When the wireless communications function is ON, communication using the DT4900-01 cannot be performed.

6.1 Repairs, Calibration, and Cleaning

 **WARNING**

- **Do not attempt to modify, disassemble, or repair the instrument yourself.**

Doing so may cause bodily injury or fire.

Calibration

IMPORTANT

Periodic calibration is necessary in order to ensure that the instrument provides correct measurement results of the specified accuracy.

The calibration interval depends on factors such as operating conditions and environment. Please determine the appropriate calibration interval based on your operating conditions and environment and contact Hioki to calibrate it accordingly on a regular basis.

When exposed to water during storage

Perform the following drain procedure to remove water drops.

DANGER

- **Remove water drops when the instrument is exposed to water during storage, and completely dry the instrument before use.**



There is a risk of electric shock if the instrument is used wet.

Bottom

Drain holes

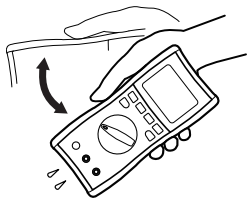

- 1** Securely hold the instrument with the drain holes away from you and shake it approximately 20 times until no water drops are coming out.

Check the safety of the surroundings and securely hold and shake the instrument.

- 2** Securely hold the instrument with the measurement terminal facing down and gently tap the instrument against a soft cloth, etc. approximately 10 times until no water drops are coming out.

Turn the rotary switch to switch the shutter and drain water from all the 3 measurement terminals.

- 3** Place the instrument on a dry towel or cloth and allow it to dry at room temperature for 2 or 3 hours.

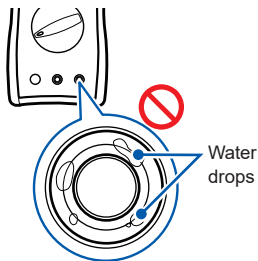

- 4** Check that there are no water drops inside the measurement terminals.

Do not use the instrument if water drops are still inside the measurement terminals.

When condensation occurs

IMPORTANT

When the instrument is returned from a high temperature/high humid environment to a room temperature environment and condensation occurs, remove the battery cover, fuse, and batteries and then allow the instrument to dry at room temperature for 24 hours or longer. Otherwise, accurate measurement may not be performed.

Cleaning

NOTICE

- **Wipe the instrument clean with a soft cloth moistened with water or a neutral detergent if the instrument becomes dirty.**



Using detergent that contains solvents such as benzene, alcohol, acetone, ether, ketones, thinners or gasoline could deform and discolor the instrument, as could wiping it with excessive force.

Wipe the LCD gently with a soft, dry cloth.

Shipping Precautions

Observe the following when shipping the instrument.

NOTICE

- **Remove the accessories and options from the instrument.**
- **Attach a description of the malfunction.**
- **Use the packaging in which the instrument was initially delivered and then pack that in an additional box.**



Failure to do so could cause damage during shipment.

Disposal

Dispose of the instrument in accordance with local regulations.

6.2 Troubleshooting

- If damage is suspected, read the section “Before returning for repair” (p. 137) to remedy the problem. If this does not help you, contact your authorized Hioki distributor or reseller.
- When sending the instrument for repair, remove the batteries and pack carefully to prevent damage in transit.
Include cushioning material so the instrument cannot move within the package. Be sure to include details of the problem.
Hioki cannot be responsible for damage that occurs during shipment.

Before returning for repair

Symptom	Check and/or remedy	Reference
Nothing appears in the display. The display disappears after a short time.	Check that the batteries are not exhausted. Replace with new batteries.	p.30
	Check that the auto power save function has not been activated. Check the setting of the auto power save function.	p.91

Continued to the next page →

Symptom	Check and/or remedy	Reference
<p>The measured value does not appear.</p> <p>Even after the measurement, 0 (zero) still appears.</p> <p>Even after short circuit of the probe, the measured value does not appear.</p> <p>Zero adjustment is not possible.</p>	If the measured current value does not appear, check that the fuse is not blown. If the fuse is blown, replace it with the specified fuse.	p.57 p.142
	If the measured current value does not appear, check that the fuse holder is not deformed. When removing the fuse, the holder is deformed if excessive force is applied. Pinch it with needle-nose pliers and restore the shape of the fuse holder.	p.142
	Check that the test lead is not broken. Perform the continuity check to confirm the continuity of the test leads. If the test lead is broken, replace the lead.	p.55
	Check that the test leads have been inserted at the ends. Check that the measurement method is correct. If no problems are found in the measurement method, the instrument may be malfunctioning. Request repair.	—
<p>The display does not stabilize and the value fluctuates; it is difficult to read the value.</p>	Check that the input signal is within the input range for the instrument. If there is any influence from noise, use the filter function of the instrument.	p.83
<p>[----] appears in the display.</p>	<p>[----] appears when the rotary switch position is not confirmed. Set the rotary switch to the proper position.</p>	p.23
<p>The display indicates an error.</p>	Check the contents of the error display. If the problem persists, request repair.	p.141

Other inquiries

Question	Solution	Reference
<p>Would like to replace the fuse.</p> <p>Would like to know how to obtain the fuse.</p>	The fuse can be purchased via authorized Hioki distributor or reseller.	p.142
<p>Would like to understand the conditions under which [FUSE OPEN] is displayed.</p>	[FUSE OPEN] is displayed if the current measurement function is selected with the rotary switch after the fuse has blown. However, the fuse is not checked when the instrument is turned on, so the message will not be shown at that time, even if the fuse is blown.	p.57
<p>Would like to use the rechargeable batteries.</p>	Rechargeable batteries can be used. However, the battery indicator will be displayed incorrectly because the discharge characteristic of these batteries is different from that of alkaline batteries.	p.30
<p>Would like to control multiple instruments with one PC.</p>	To communicate with the instrument, the DT4900-01 Communication Package (option) is required. It is possible to control multiple instruments via USB ports.	p.93
<p>The instrument cannot communicate with the PC.</p>	<p>Is the communication setting between the instrument and the PC correct?</p> <p>Are the baud rate and parity check set correctly?</p>	p.93
	<p>Is the USB cable connected correctly?</p> <p>Are the light receiving and emitting parts (communication port) clean?</p>	p.94

Continued to the next page →

Question	Solution	Reference
<p>Would like to know commands.</p> <p>Would like to perform communication using own software.</p>	<p>To communicate with the instrument, the DT4900-01 Communication Package (option) is required.</p> <p>For details on commands, see the communication specifications in the CD accompanied by the communication package. The specifications can also be downloaded from Hioki's website.</p>	<p>–</p>

6.3 Error and Operation Display

Display	Description	Solution
Err 001	ROM error (program)	Repair is necessary. Please contact your authorized Hioki distributor or reseller.
Err 002	ROM error (adjustment data)	
Err 004	Memory error (hardware malfunction)	
Err 005	ADC error (hardware malfunction)	
Err 008	Z3210 communication error (connection failure, Z3210 or hardware malfunction)	<p>Perform the following procedure. (p.42)</p> <ul style="list-style-type: none"> • Insert the Z3210 again. • Replace the Z3210 if you have another one. <p>If the error still appears on the display, it is necessary to repair the instrument. Please contact your authorized Hioki distributor or reseller.</p>
v.UP	Instrument upgrade in process	Do not remove the batteries until the upgrade is complete.

6.4 Fuse Replacement

If the fuse is blown, replace it with a new one.

The fuses can be purchased via authorized Hioki distributor or reseller.

See: "4 Check that the fuse is not blown." (p.57)

See: "Fuse replacement procedure" (p. 144)

WARNING

- **Use only fuses of the specified type, characteristics, rated current, and voltage.**

Specified fuses: For A terminal, 11 A/1000 V

Breaking capacity: 50 kA AC/30 kA DC, fast-blow type, diam. 10.3 × 38 mm, manufactured by Hollyland

Do not use any other fuse (particularly not a fuse with a higher rated current).

Do not use the instrument with the fuse holder's terminals shorted.



- **Before removing the battery cover, disconnect the instrument from the object under measurement and set the rotary switch to OFF.**

Failure to do so could cause electric shock. When the instrument is connected to the object under measurement, the battery contacts are regarded as high-voltage parts.

 **WARNING**

- **After replacing the fuse, attach and then lock the battery cover.**



Using the instrument with the cover removed could result in serious bodily injury.

Besides, the cover cannot be secured unless it is locked.

NOTICE

- **Do not apply excessive force to the fuse holder when removing the fuse.**

Applying excessive force can deform the fuse causing poor contact and the instrument may not measure the current.



- **Do not allow foreign matter to enter the instrument when replacing the fuse.**

It may cause a malfunction.

- **Do not remove the fuse using the tip of the test lead.**

Doing so can bend the tip of the test lead.

Continued to the next page →

Fuse replacement procedure

Read the precautions before performing the procedure. (p. 142)

You will need

- Phillips screwdriver (No. 2), flat-head screwdriver or coin
- Specified fuse (p. 142)

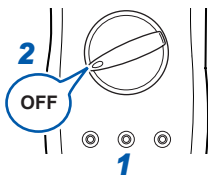

- 1 Remove the test leads from the instrument.**
- 2 Set the rotary switch to OFF.**

3 Release the locks for the battery cover.

Turn the locks 180° in the counterclockwise direction using the screwdriver or coin to align **[UNLOCKED]** with the ▲ symbol (2 places).

Rear

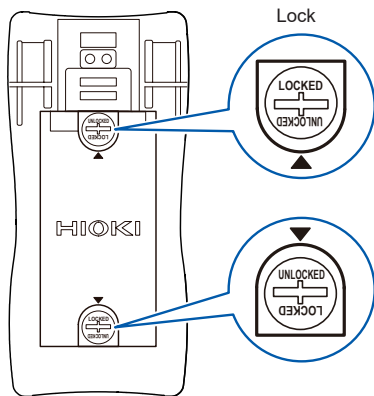

4 Remove the battery cover.

Do not remove the gasket (waterproof seal) from the battery cover.
(p.25)

5 Insert a flathead screwdriver or other suitable tool at the location shown in the figure and remove the fuse.**6 Attach a new fuse. (The fuse does not have polarity.)****7 Reattach the battery cover.****8 Lock the battery cover.**

Turn the locks 180° in the clockwise direction using the screwdriver or coin and align **[LOCKED]** with the ▲ symbol (2 places).

If the cover is not attached properly, the waterproof and dust-proof performance cannot be maintained.

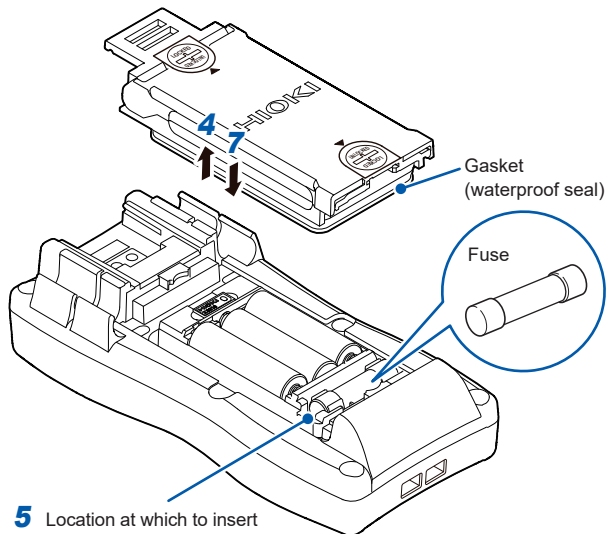

5 Location at which to insert flathead screwdriver or other suitable tool

7.1 RMS and Average

Difference between the RMS and Average

When converting AC to RMS, two methods are available, “True RMS method (True RMS indication)” and “Average method (Average rectifying RMS indication)”.

In the case of the sine wave where no skew is included, the same values are indicated in both methods. However, if the waveform is skewed, a difference occurs between the two methods.

The true RMS method is applied to this instrument.

True RMS method

It determines RMS values of AC signals, including harmonic components within the accuracy guarantee frequency range, and display them.

Average method

The input waveform is handled as a sine wave where no skew is included (only single frequency). The average of the AC signal is obtained, converted to the RMS, and then displayed. If the waveform is skewed, a greater measurement error occurs.

Measurement example	True RMS	Average rectifying RMS
100 V sine wave	100 V	100 V
100 V square wave	100 V	111 V

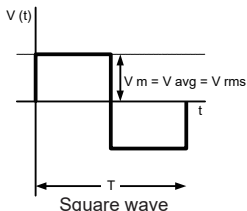
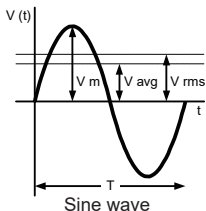

V m: Maximum value, V avg: Average value, V rms: RMS, T: Time period

Index

A

Accuracy.....	115
Alarm display.....	28
APS.....	91, 103
AUTO A.....	70
AUTO HOLD.....	80
Auto power save.....	91, 103
Auto range.....	77
AUTO V.....	59
Average value.....	86
AVG.....	86

B

Backlight.....	90, 104
Battery.....	30, 33
Buzzer sound.....	103

C

Capacitor.....	66
Carrying case.....	4
Clamp on Probe.....	4, 71
Communication.....	93, 96
Communication port.....	25
Connection cable set.....	3
Continuity.....	63
Current.....	68

D

DC High V Probe Mode.....	73
Diode.....	64
Display.....	27
Display all LCD segments....	53
Drain holes.....	26, 134

E

Electrostatic capacity.....	66
Error display.....	141
Excel® direct input function..	99

F

Filter.....	83
Frequency.....	62
Fuse.....	57, 138, 142

G

GENNECT Cross.....	96
--------------------	----

H

HID.....	99
Hold.....	79
Human Interface Device Profile.....	99

I

Inspection before use.....	51
Installation.....	14

L

L9207-10.....	39
L9300.....	36
LoZ V.....	61

M

Magnetic strap.....	45
---------------------	----

Index

Manual range.....	78
Maximum value/Minimum value	86
MAX, MIN	86
Measurement category	11
Measurement range	77
Model number display	105

O

Operation keys	20
Option	2
OVER	28

P

PC.....	93
Peak Values.....	86
Polar capacitor.....	67
Positive/negative judgment function	92
Power-On Option.....	103

R

Range	77
Red backlight.....	28
Resistance.....	65
Rotary switch	23

S

Serial number display	106
Sleeve.....	40
Software version.....	105
Specifications	109
Stand	44
Strap	45, 74

T

Test lead	35, 55
-----------------	--------

U

User setting retention function	107
---------------------------------------	-----

V

Voltage.....	58
--------------	----

W

Wireless adapter.....	41, 97
Wireless communication.....	96

Z

Z3210	41, 97, 99
Zero adjustment.....	88

Warranty Certificate

HIOKI

Model	Serial number	Warranty period Three (3) years from date of purchase (___ / ___)
-------	---------------	--

Customer name: _____

Customer address: _____

Important

- Please retain this warranty certificate. Duplicates cannot be reissued.
- Complete the certificate with the model number, serial number, and date of purchase, along with your name and address. The personal information you provide on this form will only be used to provide repair service and information about Hioki products and services.

This document certifies that the product has been inspected and verified to conform to Hioki's standards.

Please contact the place of purchase in the event of a malfunction and provide this document, in which case Hioki will repair or replace the product subject to the warranty terms described below.

Warranty terms

1. The product is guaranteed to operate properly during the warranty period (three [3] years from the date of purchase).
If the date of purchase is unknown, the warranty period is defined as three (3) years from the date (month and year) of manufacture (as indicated by the first four digits of the serial number in YYYY format).
2. If the product came with an AC adapter, the adapter is warranted for one (1) year from the date of purchase.
3. The accuracy of measured values and other data generated by the product is guaranteed as described in the product specifications.
4. In the event that the product or AC adapter malfunctions during its respective warranty period due to a defect of workmanship or materials, Hioki will repair or replace the product or AC adapter free of charge.
5. The following malfunctions and issues are not covered by the warranty and as such are not subject to free repair or replacement:
 - 1. Malfunctions or damage of consumables, parts with a defined service life, etc.
 - 2. Malfunctions or damage of connectors, cables, etc.
 - 3. Malfunctions or damage caused by shipment, dropping, relocation, etc., after purchase of the product
 - 4. Malfunctions or damage caused by inappropriate handling that violates information found in the instruction manual or on precautionary labeling on the product itself
 - 5. Malfunctions or damage caused by a failure to perform maintenance or inspections as required by law or recommended in the instruction manual
 - 6. Malfunctions or damage caused by fire, storms or flooding, earthquakes, lightning, power anomalies (involving voltage, frequency, etc.), war or unrest, contamination with radiation, or other acts of God
 - 7. Damage that is limited to the product's appearance (cosmetic blemishes, deformation of enclosure shape, fading of color, etc.)
 - 8. Other malfunctions or damage for which Hioki is not responsible
6. The warranty will be considered invalidated in the following circumstances, in which case Hioki will be unable to perform service such as repair or calibration:
 - 1. If the product has been repaired or modified by a company, entity, or individual other than Hioki
 - 2. If the product has been embedded in another piece of equipment for use in a special application (aerospace, nuclear power, medical use, vehicle control, etc.) without Hioki's having received prior notice
7. If you experience a loss caused by use of the product and Hioki determines that it is responsible for the underlying issue, Hioki will provide compensation in an amount not to exceed the purchase price, with the following exceptions:
 - 1. Secondary damage arising from damage to a measured device or component that was caused by use of the product
 - 2. Damage arising from measurement results provided by the product
 - 3. Damage to a device other than the product that was sustained when connecting the device to the product (including via network connections)
8. Hioki reserves the right to decline to perform repair, calibration, or other service for products for which a certain amount of time has passed since their manufacture, products whose parts have been discontinued, and products that cannot be repaired due to unforeseen circumstances.

HIOKI E.E. CORPORATION

<http://www.hioki.com>

18-07 EN-3

HIOKI

www.hioki.com/



**All regional
contact
information**

HEADQUARTERS

81 Koizumi
Ueda, Nagano 386-1192 Japan

HIOKI EUROPE GmbH

Helfmann-Park 2
65760 Eschborn, Germany
hioki@hioki.eu

2111 EN

Edited and published by HIOKI E.E. CORPORATION

Printed in Japan

- CE declarations of conformity can be downloaded from our website.
- Contents subject to change without notice.
- This document contains copyrighted content.
- It is prohibited to copy, reproduce, or modify the content of this document without permission.
- Company names, product names, etc. mentioned in this document are trademarks or registered trademarks of their respective companies.