



Be sure. **testo**



Made to make it easy.

Our compact professional measuring instruments deliver precise readings whenever you need them – fast, flexible, user-friendly and connected to your smartphone. Measuring couldn't be easier.

The NEW testo Compact Class

11 measuring instruments

9 measurement parameters

1 App

Endless possibilities.

Switch on, measure, and know more; immediately. Our new compact professional measuring instruments give you precise readings - easily and quickly. That is our promise to you.

Because we know that things have to move fast in your job and that you need reliable measurement results immediately in order to be able to carry on.

We also know that good measurement technology must also be smart - which is why our new Compact Class and your smartphone are true partners - thanks to the testo Smart App.

What are you waiting for?



Vane anemometer
testo 417
fpm, cfm, °F
m/s, m³/h, °C

Vane anemometer
testo 416
fpm, cfm
m/s, m³/h

Hot wire anemometer
testo 425
fpm, cfm, °F
m/s, m³/h, °C

CO₂ measuring instrument
testo 535
CO₂

Lux meter
testo 545
Lux

Digital thermohygrometer
testo 625
°F, %RH, °Fwb, °Ftp
°C, °Cwb, °Ctp

Pressure measurement

Temperature



Differential pressure measuring instrument
testo 512-1
psi, fpm, cfm
hPa/mbar, m/s, m³/h

Differential pressure measuring instrument
testo 512-2
psi
hPa/mbar

Differential temperature measuring instrument
testo 922
°F
°C

Temperature measuring instrument
testo 925
°F
°C

NTC+ PT100 Temperature measuring instrument
testo 110
°F
°C

Compact precision for your jobs.

Testo's new compact professional measuring instruments are always there when you need accurate readings fast.

Little time, endless to-do lists and complex tasks: These are the moments when the new compact measuring instruments from Testo are reliably at your side.

The right instrument for every relevant measurement

parameter: Simply turn it on and right away you have exactly the reading you need to make the right decisions. In all important applications - **fast, simple and precise.**

And with the **testo Smart App**, you not only have the most important measurement menus with you at all times - documentation and measured value storage are possible at any time with your smart assistant (see App info from p. 12).



Easy

- Compact design: Readily available, quickly stowed away.
- Robust workmanship: When the going gets tough.
- Intuitive operation: High-tech reduced to the essentials.
- Print reports on site: Everything in black and white.
- testo Smart App: Configure, save, document measurements, and much more (see p. 12).



Each instrument comes in a practical, compact, and robust testo Smart Case



Fast

- Measurement results immediately: **With one look, everything is clear.**
- Configuration with the testo Smart App: **Change settings with just a few clicks.**
- Automatic volume flow calculation: **The duct diameter is enough.**
- Two displays show more than one: **Show your customers measurement curves on a smartphone, In real time.**



Precise

- Digital probes proven in practice: **For long-term stable, reproducible and accurate measurement results.**
- Helpful measurement menus: **Single-point and time curve measurement in every instrument.**
- Complex measurements, compactly simplified: **For example, very easy measurement, adjustments, and documentation of living space ventilation.**
- Documentation with the testo Smart App: **Completely without paperwork.**





Air conditioning and ventilation systems easily under control.

Compact flow velocity and volume flow measurement.

To ensure that people enjoy spending time indoors, air conditioning and ventilation systems are a crucial factor for modern buildings.

Accordingly, it is important to ensure with the appropriate measurement technology that sufficient fresh air is supplied to the rooms and that stale air is discharged, with the best possible efficiency, for all VAC units.

With the new flow velocity measuring instruments from Testo, you can perform these tasks quickly, easily, precisely, and with smart App support: **In ducts, at the outlets** and when **adjusting the balanced residential ventilation.**

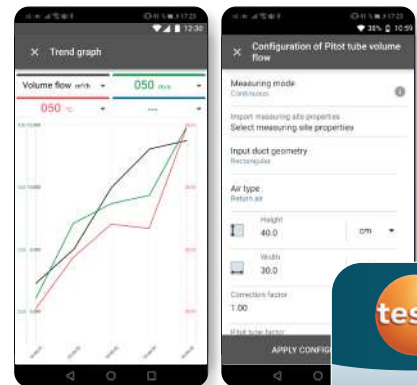

This is how the testo Smart App supports you

- Configure your measuring instrument
- Display graphical measured value curve
- Save measurement data
- Customer and measuring location management
- Documentation of your work
- E-mail dispatch of the report
- Second screen capability

testo 417 Digital 4 inch vane anemometer

Simple, fast and precise measurement of flow, volume flow and temperature at air inlets and outlets

- Efficient regulation of balanced residential ventilation and fast documentation with the testo Smart App
- Fast in-app configuration, graph history, second screen and measurement data memory in the testo Smart App
- Timed and multi-point mean calculation
- Durability through compact design with robust housing

Order no. 0563 0417



testo 417 kit 1

Incl. funnel kit for plate outlets and ventilation grills.

Order no. 0563 1417



testo 417 kit 2

Includes kit 1, plus flow straightener for swirl vents.

Order no. 0563 2417



testo 416 Digital 5/8 inch vane anemometer

Simple, fast and precise flow measurement & volume flow calculation in the ventilation duct

- More flexibility for duct measurements with the cable-connected telescopic probe (maximum length 33 in.)
- Fast in-app configuration, graph history, second screen and measurement data memory in the testo Smart App
- Timed and multi-point mean calculation
- Durability through compact design with robust housing

Order no. 0563 0416

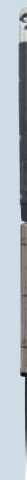

Digital hot wire anemometer testo 425

Simple, fast and precise flow and temperature measurement plus volume flow calculation in the ventilation duct

- More flexibility for duct measurements with the cable-connected telescopic probe (maximum length 32 in.)
- Fast in-app configuration, graph history, second screen and measurement data memory in the testo Smart App
- Timed and multi-point mean calculation
- Durability through compact design with robust housing

Order no. 0563 0425





Comfort **easily under control.**

For a more comfortable indoor climate.

Living, working or leisure: We spend almost 90% of our time indoors every day! The topics of **indoor air quality and comfort** could therefore hardly be more important for well-being and health.

With the new compact measuring instruments from Testo, you have CO₂, illuminance, temperature, and air humidity; quickly, easily, and precisely in view - and therefore ensure comfort and a healthy climate indoors.



Digital CO₂ measuring instrument testo 535

Simple, fast and precise measurement of CO₂ concentration

- Audible alarm sounds if a limit value is exceeded
- Fast in-app configuration, graph history, second screen and measurement data memory in the testo Smart App
- High reproducibility of measurement results due to long-term stable infrared sensor technology
- Timed and multi-point mean calculation

Order no. 0563 0535 01



This is how the testo Smart App supports you

- Configure your measuring instrument
- Display graphical measured value curve
- Save measurement data
- Customer and measuring location management
- Documentation of your work
- E-mail dispatch of the report
- Second screen capability



Digital lux meter testo 545

Simple, fast and precise measurement of illuminance (lux) according to the V-lambda curve for all common light sources

- Wide range of applications due to LED compatibility (except single-color blue LED)
- Fast in-app configuration, graph history, second screen and measurement data memory in the testo Smart App
- Audible alarm sounds if a limit value is exceeded
- Timed and multi-point mean calculation

Order no. 0563 1545



Digital thermohygrometer testo 625

Simple, fast and precise measurement of air temperature and relative humidity

- Calculation of dewpoint and wet bulb temperature
- Fast in-app configuration, graph history, second screen and measurement data memory in the testo Smart App
- Audible alarm sounds if a limit value is exceeded
- Timed and multi-point mean calculation

Order no. 0563 1625



Pressure measurement **easily under control.**

Compact pressure measurement.

The new compact measuring instruments from Testo are also reliably at your side for two of the most important measurements on heating systems. For fast measurement results when it counts.

With the differential pressure measuring instrument testo 512, you can check the gas pressure on burners quickly and precisely by measuring gas flow pressure and static gas pressure - indispensable for maintenance work on **heating systems**.

testo 512 is also your reliable partner for **general pressure measurement, checking filters** and **Pitot tube measurement**.

With the testo 922 differential temperature measuring instrument, (p. 11), you have the supply/return temperature on heating circuit distributors under control.



Pro tip:
Ideal for measuring gas flow/static gas pressure.

Digital differential pressure measuring instrument testo 512-1

- Simple, fast and precise differential pressure measurement (0 to 80 inH₂O) for checking filters and for Pitot tube measurement in the air duct
- Reliable measurement results due to position-independent differential pressure sensor with high accuracy
- Fast in-app configuration, graph history, second screen and measurement data memory in the testo Smart App
- Volume flow calculation in measuring instrument and App
- Audible alarm sounds if a limit value is exceeded

Order no. 0563 1512



Pro tip:
Ideal for measuring high pressures.

Digital differential pressure measuring instrument testo 512-2

- Simple, fast and precise differential pressure measurement (0 to 800 inH₂O)
- Fast in-app configuration, graph history, second screen and measurement data memory in the testo Smart App
- Audible alarm sounds if a limit value is exceeded
- Timed and multi-point mean calculation
- Durability through compact design with robust housing

Order no. 0563 2512

This is how the testo Smart App supports you

- Configure your measuring instrument
- Display graphical measured value curve
- Save measurement data
- Customer and measuring location management
- Documentation of your work
- E-mail dispatch of the report
- Second screen capability





Pro tip:
Ideal for measuring flow/
return temperature.

Temperatures easily under control.

Measure the most important measurement value compactly.

Digital differential temperature measuring instrument testo 922

Easy, fast and precise differential temperature measurement with dual thermocouple Type K probe (2 TC Type K probes included)

- Fast in-app configuration, graph history, second screen and measurement data memory in the testo Smart App
- Wide range of applications due to large measuring range from -58 to 1,832 °F
- Large sensor selection optional and compatible with commercially available TC Type K sensors
- Audible alarm sounds if a limit value is exceeded

Order no. 0563 0922



Digital temperature measuring instrument testo 925

Easy, fast and precise temperature measurement with thermocouple Type K probe (1 TC Type K probe included)

- Fast in-app configuration, graph history, second screen and measurement data memory in the testo Smart App
- Wide range of applications due to large measuring range from -58 to 1,832 °F
- Large sensor selection optional and compatible with commercially available TC Type K sensors
- Audible alarm sounds if a limit value is exceeded

Order no. 0563 0925



Temperature measurement in laboratory and food environment

Temperatures in the laboratory and food environment easily under control.

Particularly precise, even at low temperatures.

Digital temperature measuring instrument testo 110

Simple, fast and particularly precise temperature measurement with NTC or Pt100 sensor (optionally available)

- Fast in-app configuration, graph history, second screen and measurement data memory in the testo Smart App
- HACCP-compliant, certified according to EN 13485 for use in the food sector
- High-precision measurement results and high system accuracy with digital Pt100 sensors (calibration without measuring instrument)
- Audible alarm sounds if a limit value is exceeded

Order no. 0563 0110



One App for everything: **That's smart!**

The testo Smart App will become your trusted partner.

What's special about the new ones from Testo: You can configure and use them according to your needs. Just measure and nothing more? Not an issue at all. But you have other settings in mind, you would like to save the measured values, and documentation is also important?

Easy to use - with the testo Smart App. Get the most out of your new measuring instrument with the free App. And of course, the App and the measuring instrument simply connect automatically.

Easy

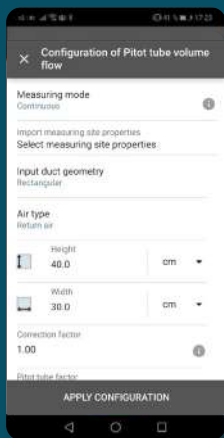

- Intuitive measurement menus
- Quick configuration
- Uncomplicated documentation

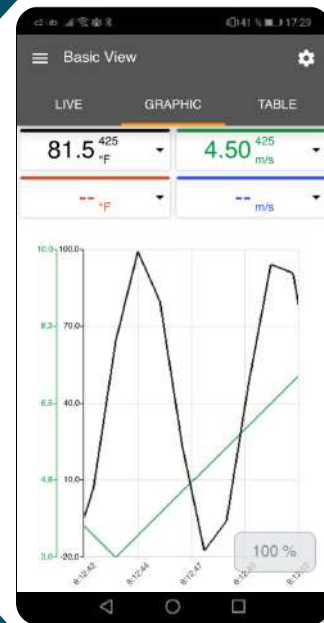

Fast

- Measurements displayed in just a few clicks
- All measurement values at a glance
- Graphic or tabular curve display

Efficient

- Storage of measurement and customer data
- Easy report generation and dispatch by e-mail
- Second display

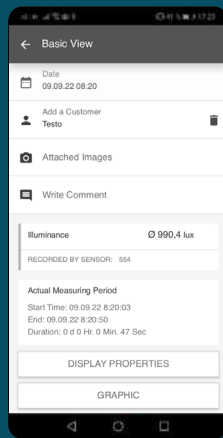
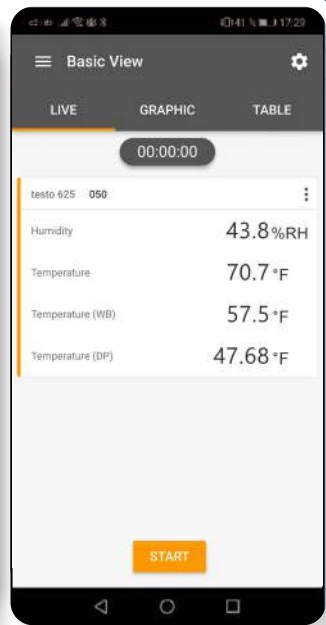





Clever



- Data exchange with PC software testo DataControl
- Continuous updates and extensions
- Free download, free use





Want to be sure? Good.

All technical data at a glance.

Air conditioning and ventilation systems						
Product	testo 416	testo 417	testo 417 kit 1	testo 417 kit 2	testo 425	
Description	5 in, vane anemometer with App connection, fixed telescope (max. 33 in.), incl. transport bag and calibration protocol	4 inch vane anemometer with App connection, incl. transport bag and calibration protocol	4 inch vane anemometer with App connection, incl. measuring funnel for plate outlets, measuring funnel for ventilation grills, transport bag and calibration protocol	4 inch vane anemometer with App connection incl. measuring funnel for plate outlets, measuring funnel for ventilation grills, flow straightener, transport bag and calibration protocol	Thermal hot wire anemometer with App connection, fixed telescope (max. 32 in.), incl. transport bag and calibration protocol	
Measurement parameter	m/s, fpm, m ³ /h, cfm, l/s		m/s, fpm, °F, °C, m ³ /h, cfm, l/s		m/s, fpm, °F, °C, m ³ /h, cfm, l/s	
Measuring range	118.1 to 7,874 fpm		59.1 to 3,937 fpm 32° to 122 °F		0 to 5,905 fpm -4° to 158 °F	
Accuracy	±(0.2 m/s + 1% of reading)		±(19.7 fpm + 1.5 % of M.V) ±0.9 °F		±(5.91 fpm + 4% of m.v.) (0 to 3,937 fpm) ±(98 fpm + 5% of m.v.) (3937.1 to 5,905 fpm) ±0.9 °F	
Resolution	0.1 fpm		0.01 fpm 0.1 CFM (0 to +58.8 CFM) 1 CFM (+59 to +58857 CFM) 0.1 °F		0.01 fpm 0.1 °F	
Classification	IP40 (probe: IP20)		IP40 (probe: IP20)		IP40 (probe: IP20)	
Battery (incl.)	3 x AA		3 x AA		3 x AA	
Battery life (h)	60		50		35	
Connection testo Smart App	✓		✓		✓	
Order no.	0563 0416	0563 0417	0563 1417	0563 2417	0563 0425	

Pressure measurement			
Product	testo 512-1	testo 512-2	
Description	Differential pressure measuring instrument with App connection, measuring range 0 to 80 inH ₂ O, audible alarm, incl. transport bag and calibration protocol	Differential pressure measuring instrument with App connection, measuring range 0 to 800 inH ₂ O, audible alarm, incl. transport bag and calibration protocol	
Measurement parameter	Pa, hPa/mbar, kPa, psi, inHg, inH ₂ O, mmH ₂ O, mmHg, m/s, fpm, m ³ /h, cfm, l/s	Pa, hPa/mbar, kPa, psi, inHg, inH ₂ O, mmH ₂ O, mmHg	
Measuring range	0 to 80 inH ₂ O	0 to 800 inH ₂ O	
Accuracy	±(0.001 inH ₂ O + 1% of m.v.) ±1 digit (0 to 10 inH ₂ O) ±(0.04 inH ₂ O + 1.5% of m.v.) ±1 digit (10.01 to 80 inH ₂ O)	0.5 %fs	
Solution	0.001 hPa	1 hPa	
Classification	IP 40	IP40	
Battery (incl.)	3 x AA	3 x AA	
Battery life (h)	120	120	
Connection testo Smart App	✓	✓	
Order no.	0563 1512	0563 2512	

Comfort level			
Product	testo 535	testo 545	testo 625
Description	CO ₂ measuring instrument with App connection, audible alarm, incl. transport bag and calibration protocol	Lux meter with App connection, audible alarm, incl. transport bag and calibration protocol	Humidity and temperature measuring instrument with App connection, audible alarm, incl. transport bag and calibration protocol
Measurement parameter	ppm, %	lux, fc	%RH, °F, °F td, °F dp °C, °C td, °C dp
Measuring range	0 to 10,000 ppm	0 to 100,000 lux	0 to 100 %RH -4 to 140 °F
Accuracy	±100 ppm +5 % of mv	±3% of m.v. ±1 digit (Class C, corresponding to DIN 5032-7 / EN 13032-1, Appendix B f1 = 6% = V(Lambda) adjustment f2 = 5% = cos-true evaluation Total ≤15%)	2.5 %RH (5 to 95 %RH) ±0.9 °F
Solution	1 ppm	0.1 lux (<10,000 lux) 1 lux (≥10,000 lux)	0.1 %RH 0.1 °F
Classification	IP40 (probe: IP20)	IP40 (probe: IP20)	IP40 (probe: IP20)
Battery	3 x AA	3 x AA	3 x AA
Battery life	30	70	100
Connection testo Smart App	✔	✔	✔
Order no.	0563 0535 01	0563 1545	0563 1625



Temperature			
Product	testo 922	testo 925	testo 110
Description	2-channel temperature measuring instrument TC Type K with App connection, audible alarm, incl. transport bag, 2 x TC Type K probes and calibration protocol	1-channel temperature measuring instrument TC Type K with App connection, audible alarm, incl. transport bag, 1 x TC Type K probes and calibration protocol	1-channel temperature measuring instrument NTC / Pt100 with App connection, TUC probe socket, audible alarm, incl. transport bag and calibration protocol
Measurement parameter	°F, °C	°F, °C	°F, °C
Measuring range	-58 to 1,832 °F	-58 to 1,832 °F	NTC: -58 to 302 °F Pt100: -328 to 1,472 °F
Accuracy	±(0.9 °F + 0.3% of m.v.) (-58 to 1,832 °F)	±(0.9 °F + 0.3% of m.v.) (-58 to 1,832 °F)	NTC: ±0.36 °F (-4 to +176 °F) ±0.54 °F (remaining meas. range) Pt100: according to the probe accuracy
Solution	0.1 °F (-58 to 931.8 °F) 1 °F (rem. measuring range)	0.1 °F (-58 to 931.8 °F) 1 °F (rem. measuring range)	NTC: 0.1 °F Pt100: according to the probe accuracy
Classification	IP40 (optional TopSafe IP65)	IP40 (optional TopSafe IP65)	IP40 (optional TopSafe IP65)
Battery	3 x AA	3 x AA	3 x AA
Battery life	120	150	100
Connection testo Smart App	✔	✔	✔
Order no.	0563 0922	0563 0925	0563 0110

Accessories & probes

More probes at www.testo.com

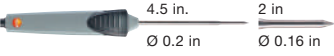
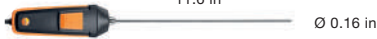
Accessories	Order no.
TopSafe protective silicone cover for testo 922/925/110 for IP65	0516 0224
Bluetooth®/IRDA printer incl. battery and power supply 	0554 0621
Spare thermal paper for printer (6 rolls), measurement data documentation can be read for up to 10 years	0554 0568

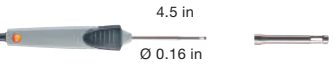
Probe type	Probe shaft/probe shaft tip dimensions	Measuring range	Accuracy	Response time	Order no.
NTC/PT100 for testo 110 Pipe wrap probe (NTC) for pipe diameters of 0.2 to 2.5 in., fixed cable 3.9 ft		-58 to 248 °F	±0.36 °F (-13 to +176 °F)	–	0615 5605
Waterproof NTC immersion/penetration probe, fixed cable 3.9 ft.	 4.5 in. 2 in. Ø 0.2 in Ø 0.16 in	-58 to 257 °F	±0.5% of m.v. (212 to 302 °F) ±0.4 °F (-13 to 166.8 °F) ±0.7 °F (remaining meas. range)	10 s	0615 1212
High-precision digital Pt100 penetration probe for measurements in liquids and pastes with an accuracy of up to ±0.09 °F	 11.6 in Ø 0.16 in	-112 to 572 °F	±0.54 °F (-112 to -40.001 °F) ±(0.18 °F + 0.05% of m.v.) (-40 to 31.9 °F) ±0.09 °F (32 to 212 °F) ±(0.09 °F + 0.05% of m.v.) (212.01 to 572 °F)	t ₉₀ <45 sec	0618 0275

Probe type	Dimensions	Measuring range	Accuracy	Response time	Order no.
Type K For testo 922/925 Robust air probe, TC Type K, fixed cable	 4.5 in Ø 0.16 in	-76 to 752 °F	Class 2 ¹⁾	200 sec	0602 1793
Very fast-reaction surface probe with sprung thermocouple strip, also suitable for uneven surfaces, measuring range briefly up to 932 °F, TC Type K, fixed cable	 4.5 in. Ø 0.19 in. Ø 0.47 in.	-76 to 572 °F	Class 2 ¹⁾	3 sec	0602 0393
Immersion measuring tip, flexible, for measurements in air/flue gases (not suitable for measurements in smelters), TC Type K	 Ø 0.12 in 39.4 in.	-40 to 1,832 °F	Class 1 ¹⁾	4 sec	0602 5693

¹⁾ According to standard EN 60584-1, the accuracy of Class 2 refers to -40 to 2,192 °F.



Subject to change, including technical modifications. 2981 1434/B&B/msp/12.2022